

eltherm[®]
innovations in heat tracing



















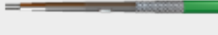

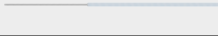

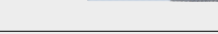



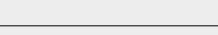









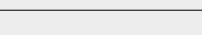





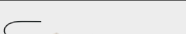

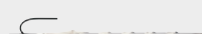



Heating Cables

Heating Tapes

innovations in heat tracing

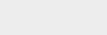

Table of Contents

Introduction				3
	Type ELP/SI	Constant Wattage Heating Cable up to 200 °C		4-5
	Type ELP/SI-F	Constant Wattage Heating Cable up to 200 °C		6-7
	Type ELP/PFA	Constant Wattage Heating Cable up to 260 °C		8-9
	Type ELP-FEP	Constant Wattage Heating Cable up to 200 °C		10-11
	Type ELKM-A	Heating Cable up to 260 °C		12-13
	Type ELKM-AS	Heating Cable up to 260 °C		14-15
	Type ELKM-AE	Heating Cable up to 260 °C		16-17
	Type ELKM-AG-L	Heating Cable up to 260 °C		18-19
	Type ELKM-AG-N	Heating Cable up to 260 °C		20-21
	Type ELK-AE	Heating Cable up to 260 °C		22-23
	Type ELK-AG-L	Heating Cable up to 260 °C		24-25
	Type ELK-AG-N	Heating Cable up to 260 °C		26-27
	Type ELW-GN	Heating Tape up to 260 °C		28-29
	Type ELW-VA	Heating Tape up to 260 °C		30-31
	Type ELK-H	Heating Cable up to 450 °C		32-33
	Type ELK-HS	Heating Cable up to 450 °C		34-35
	Type ELW-H	Heating Tape up to 450 °C		36-37
	Type ELW-HS	Heating Tape up to 450 °C		38-39
	Type ELK-Q	Heating Cable up to 900 °C		40-41
	Type ELW-Q	Heating Tape up to 900 °C		42-43
	Type ELTC-14	Electronic Temperature Controller		44-45
	Type ELTC-21	Electronic Temperature Controller		46
	Type ELTC-22	Electronic Temperature Controller		47
	Junction Boxes			48-53
	Accessories overview			54-57
	Cable overview			58-59

eltherm – Your reliable and competent partner with several years of experience in the field of electrical heat tracing. You wish to transfer heat to the media or compensate heat loss? eltherm provides the solution.

Our well-founded and expert knowledge, which is based on state-of-the-art technology, is always available to you. Quality is both produced and lived at eltherm. Moreover, we have achieved DIN ISO 9001:2008 and ISO 14001 certification.

The latest IT, planning and testing systems ensure quality and timely manufacturing processes.

In close collaboration with the customers, eltherm develops individually tailored solutions, supporting them when planning, proposing and assembling electrical heating systems. A perfected, high-quality product program enables eltherm to find the most reasonable economical solution for you.

Our results are convincing.

Further documents are available with information about our high-quality products:

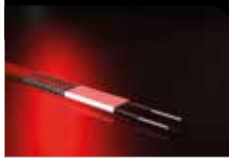

Self-regulating Heating Cables



Heated Hoses

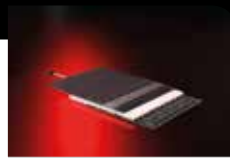

Heating Mats Heating Jackets



Special Heating Systems



Measurement and Control

Important information

Products marked with the -symbol can be used in hazardous areas. The temperatures allocated to the products are the maximum permissible exposure temperatures. Our project engineers will be glad to assist you to design and dimension electrical heat tracing systems. Moreover, we have prepared a questionnaire which helps you to record operating data and enable correct dimensioning and allocation. We would be happy to send you the questionnaires for the respective product, to elaborate a customized solution for your application and to submit you our offer. All products listed in the catalogue are available ex stock (subject to prior sale). All products offered in this catalogue can also be manufactured by eltherm using different dimensions, outputs and voltages.

Furthermore, please note:

- All products listed in this catalogue shall only be connected and commissioned by a qualified electrician.
- All applicable local electrical and safety regulations must be observed during installation and operation.
- Normally, electrical heating systems require a temperature control unit as it is only possible to ensure that the exposure temperatures for the electrical heating and products to be heated are not exceed if such a unit is used.
- As a general rule, the following specifications of the standards EN 60519-1-2-10 and EN 62395-1 shall be respected for the operation of electrical heatings.

- We recommend to use a temperature control system in conjunction with a stabilized system design or a temperature limiter to avoid damages to persons and material.
- In accordance with EN 62395-1 and EN 60519-10, residual current devices (RCDs) are to be provided in order to disconnect from the mains in good time and to avoid consequential damages.
- Attention: heating cable and heating tape may neither intersect nor come into contact. There is the danger of burnout due reciprocal heating up (except: type ELSR).
- Our general assembly and operating instructions for this product are valid for the use of the heating cables.

Specifications and advertising messages in this products and services catalogue, irrespective of their nature, in particular descriptions, illustrations, drawings, samples, information pertaining to quality, condition, composition, performance, consumption and usability as well as dimensions and weights of the product range remain subject to change in as far as they are not expressly declared as binding. They do not denote any assurance or guarantee whatsoever. Minor deviations from the product specifications shall be deemed approved in as far as they are not unreasonable for the buyer.

We explicitly reserve the right to amend errors and alter technical data.



Coil ware



ESTI: Approval for the Swiss market



NEMKO: Approval for the Norwegian market



Suitable for contact with foodstuffs/approved for use in potable water



EAC: Approval for the Russian market



NEPSI: Hazardous Area Products for Chinese Market



Certified according to VDE standards



Approval for the French market



KTL: Korean Testing Laboratory for Hazardous Area Products



Ship Classification Maritime Service



IECEX: Certified according to IECEx-scheme



Expolabs: Approval for the South-African Market (Ex, IA approval)



INMETRO: Approval for the Brazilian market



Hyg, DVGW, KTW: Certification Body, Approval for Usage in Drinking Water



ABS: American Bureau of Shipping - Product Design Assessment Certificate

Constant Wattage Heating Cable with Resistance Wire

The installation of this heating cable is highly cost-efficient with any kind of heat tracing application thanks to the single end power input. The heating cable consists of a succession of heating zones (length = contact spacing) and can be cut to length in sections of the contact distance to the required length. When cutting into lengths, the heating circuit is interrupted up to the next contact point and this non-active part can be used as a cold lead. During the design phase, one contact spacing length per planned heating circuit must be calculated additionally.

Advantages:

- Single end connection
- Can be cut off the roll
- Constant power output per meter
- Highly flexible

Applications:

- Vessels, piping, valves
- Food processing industry
- Frost protection and temperature maintenance on pumps, etc.



Type **ELP/Si** up to 200 °C

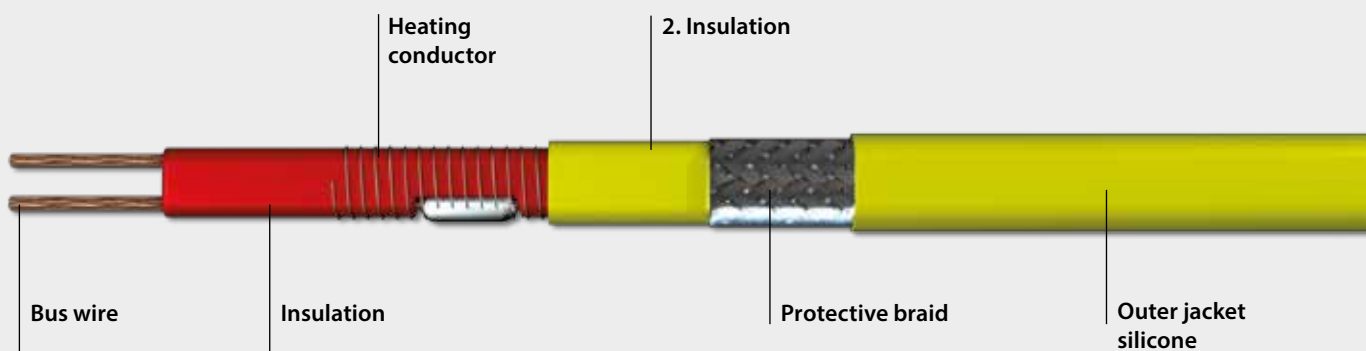



Technical Information

Type ELP/Si up to 200 °C

Data

■ Insulation	Silicone
■ Protective braid	Copper
■ Outer jacket	Silicone
■ Nominal temperature	200 °C
■ Moisture proof	Yes
■ Bending radius, min.	30 mm
■ Bus wire cross section	2 x 1.5 mm ²
■ Nominal voltage	230 V AC/DC
■ Installation temp., min.	-60 °C
■ Start-up temp., min	-60 °C

Cables shall neither intersect nor contact.
Provide protection by means of circuit breaker FI 30.
Please observe the standards IEC 62395-2, EN 60519-10.

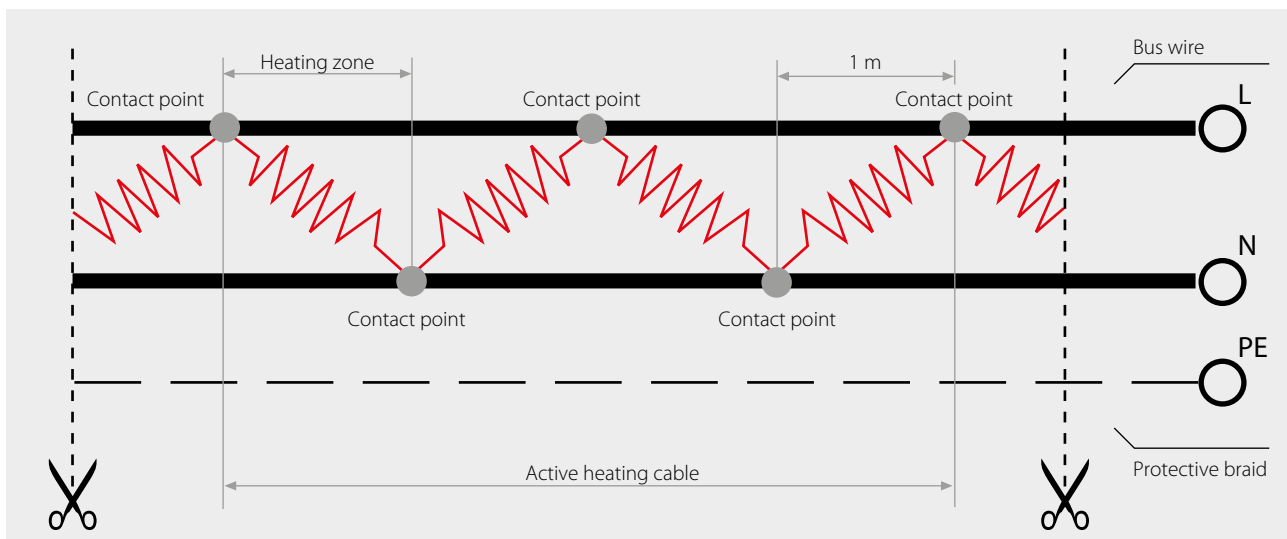

Type	Nominal output	Dimensions approx. (mm)	Contact spacing (m)	Art. No.
ELP/Si 10 BO 230	10 W/m	5.25 x 9.75	1.0	0320102
ELP/Si 20 BO 230	20 W/m	5.25 x 9.75	1.0	0320108
ELP/Si 30 BO 230	30 W/m	5.25 x 9.75	1.0	0320114
ELP/Si 40 BO 230	40 W/m	5.25 x 9.75	1.0	0320120

Constant wattage heating cables up to nominal voltages of 120 V or 400 V are available upon request. Bus wire cross section 2 x 2 mm² upon request.

Maximum heating circuit length

Type	W/m	Length (m) at 50 °C	Length (m) at 150 °C
ELP/Si 10 BO 230	10	198	147
ELP/Si 20 BO 230	20	139	102.5
ELP/Si 30 BO 230	30	98	82.5
ELP/Si 40 BO 230	40	73.5	70.5

Heating circuit lengths ELP/Si on the following conditions

- 16 A circuit breaker, 80 % utilisation
- Max. 10 % voltage drop
- Power connection to one (1) heater end

Constant Wattage Heating Cable with Resistance Wire

These heating cables are particularly suitable for maintaining temperatures of up to +150 °C. Its great flexibility down to - 70°C means that this version is ideal for heat tracing in industrial refrigeration or in countries with very harsh climates.

The heating cable consists of a succession of heating zones (length = contact spacing) and can be cut to length in sections of the contact distance to the required length. When cutting into lengths, the heating circuit is interrupted up to the next contact point and this non-active part can be used as a cold lead. During the design phase, one contact spacing length per planned heating circuit must be calculated additionally.

Advantages:

- Single end connection
- Can be cut off the roll
- Constant power output per meter
- Highly flexible

Applications:

- Vessels, piping, valves
- Food processing industry
- Frost protection and temperature maintenance on pumps, etc.
- Filter heating systems



Type ELP/Si-F up to 200 °C

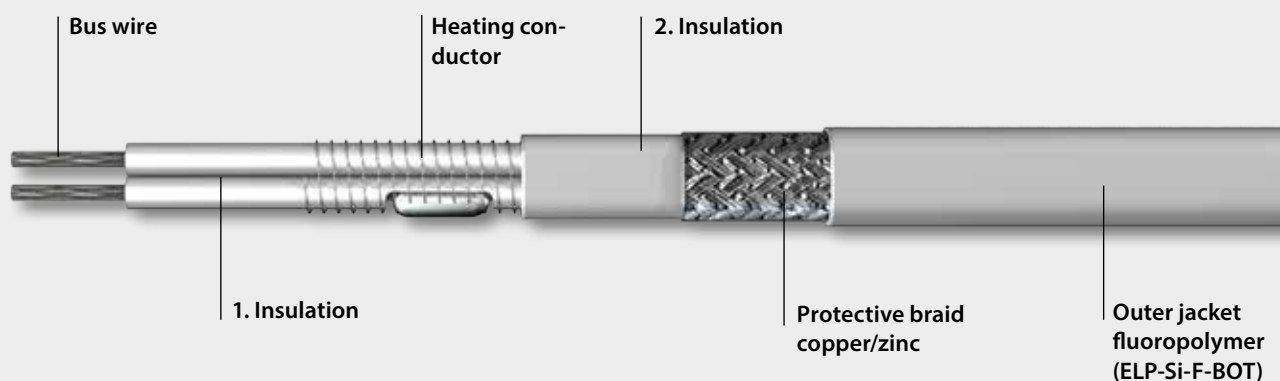



Technical Information

Type ELP/Si-F up to 200 °C

Data ELP/Si-F-B

■ Insulations	Silicone
■ Protective braid	Copper/zinc
■ Outer jacket	Silicone
■ Nominal voltage	230 V AC/DC or 400V AC/DC
■ Dimensions	6.5 x 10.5 mm
■ Permissible ambient temperature	-70...+200 °C
■ Bending radius, min.	30 mm
■ Bus wire cross section	2 mm ²
■ Installation temp., min.	-70 °C
■ Start-up temp., min	-70 °C

Data ELP/Si-F-BOT

■ Insulations	Silicone
■ Protective braid	Copper/zinc
■ Outer jacket	Fluoropolymer
■ Nominal voltage	230 V AC/DC or 400V AC/DC
■ Dimensions	7 x 10.5 mm
■ Permissible ambient temperature	-70...+200 °C
■ Bending radius, min.	30 mm
■ Bus wire cross section	2 mm ²
■ Installation temp., min.	-70 °C
■ Start-up temp., min	-70 °C

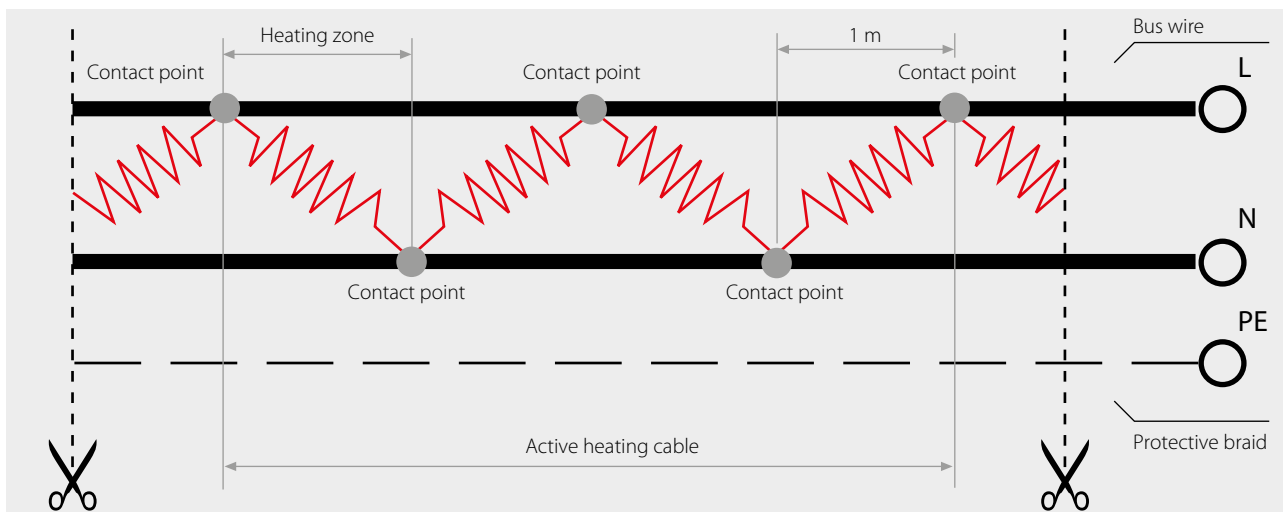

Maximum heating circuit length

Type	Nominal output (W/m)	Contact spacing (m)	Length (m) at 10 °C	Length (m) at 100 °C	Maximum maintenance temperature °C	Nominal voltage (V)	Art. No.
ELP/Si F 20 B	20	0.7	147	141	150	230	0320210
ELP/Si F 30 B	30	0.7	98	98	140	230	0320211
ELP/Si F 40 B	40	0.6	73.5	73.5	120	230	0320212
ELP/Si F 40 B	40	1.0	128	128	120	400	0320312
ELP/Si F 20 BOT	20	0.7	147	141	150	230	0320220
ELP/Si F 30 BOT	30	0.7	98	98	140	230	0320221
ELP/Si F 40 BOT	40	0.6	73.5	73.5	120	230	0320222
ELP/Si F 40 BOT	40	1.0	128	128	120	400	0320322

Heating circuit lengths ELP/Si-F on the following conditions

- 16 A circuit breaker, 80 % utilisation
- Max. 10 % voltage drop
- Power connection to one (1) heater end

Cables shall neither intersect nor contact. Provide protection by means of circuit breaker FI 30. Please observe the standards IEC 62395-2, EN 60519-10.

Constant wattage heating cables up to nominal voltages of 120 V are available upon request.

Constant Wattage Heating Cable with Resistance Wire

These parallel heating cables offer tremendous flexibility in use, as they can easily be cut to the required length off the roll, with the assurance of constant power output. There is no need for a connecting cable and input can be unilateral. It is quick and easy to assemble; this saves a lot of time, and reduces costs considerably as a result. Since output of up to 60 W/m is possible for lengths laid to piping, ELP parallel heating cables are particularly suitable for piping with high output requirements such as in industrial process technology. The particularly temperature-resistant outer shell in PFA and the high level of chemical resistance of the PFA ensure a long useful life.

Advantages:

- Single end power input
- Can be cut off the roll
- Constant power output per meter
- Long life cycle
- Laying without exact measuring possible
- High chemical resistance
- UV resistance

Applications:

- Vessels, piping, valves
- Building construction
- Food processing industry
- Paper industry



Type ELP/PFA up to 260 °C

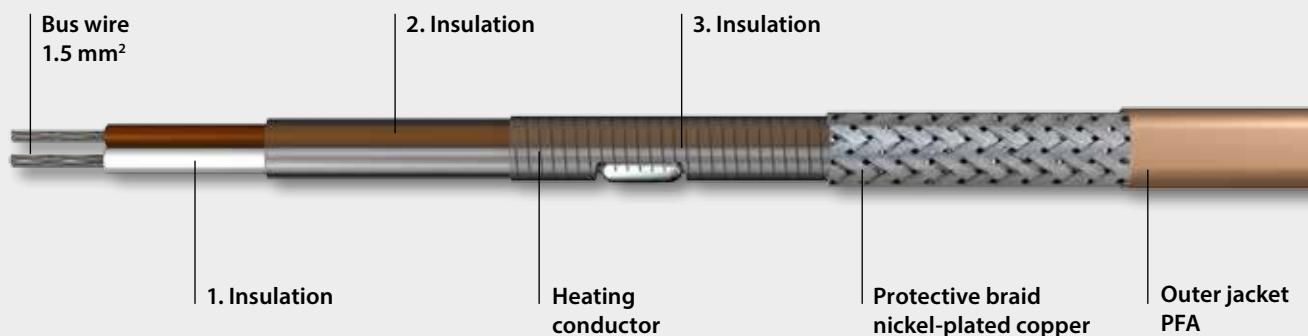



Technical Information

Type ELP/PFA up to 260 °C

Data

■ Insulations	PFA
■ Protective braid	Nickel-plated copper
■ Outer jacket	PFA
■ Nominal temperature	260 °C
■ Moisture proof	Yes
■ Bending radius, min.	25 mm
■ Bus wire cross section	2 x 1.5 mm ²
■ Nominal voltage	230 V AC/DC
■ Installation temp., min.	-45 °C
■ Start-up temp., min.	-45 °C

Standards

■ Manufactured according to	DIN VDE 0721-52 EN 62395-1; 2007-05
■ Certificates	12ATEX1438U IECEX EPS 12.0009U
■ Classification	II 2G Ex e IIC Gb II 2D Ex tb IIIC Db

Cables shall neither intersect nor contact.
Provide protection by means of circuit breaker FI 30.
Please observe the standards IEC 62395-2, EN 60519-10.

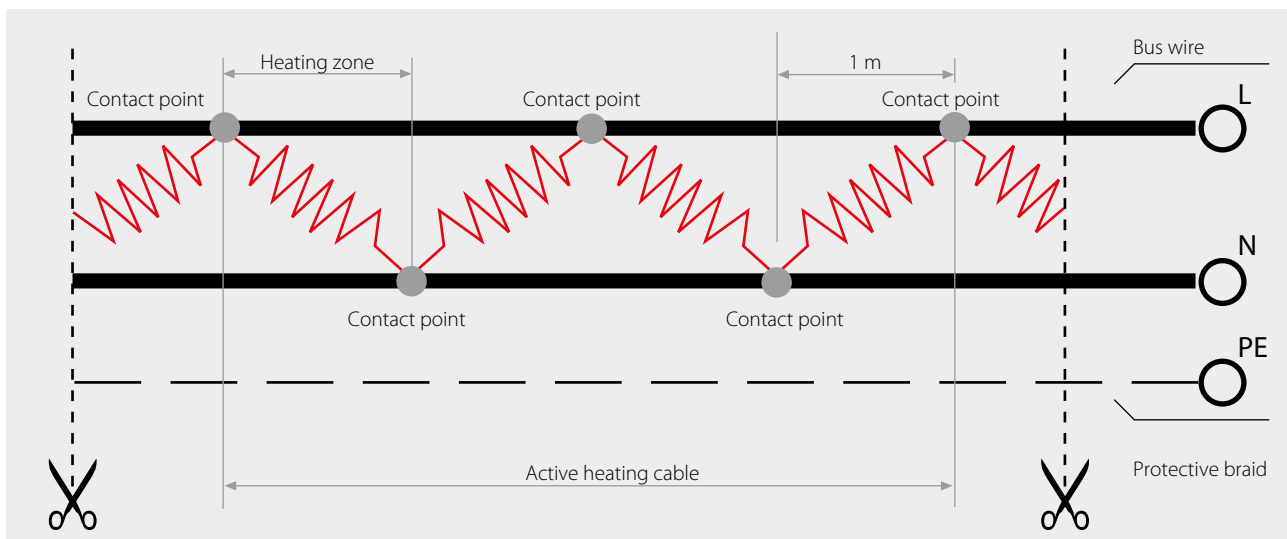

Type	Nominal output	Working temp. max	Dimensions approx. (mm)	Contact spacing (m)	Art. No.
ELP/PFA 15 BOT	15 W/m	205°C	8.0 x 5.5	1.0	B0332015
ELP/PFA 30 BOT	30 W/m	190°C	8.0 x 5.5	1.0	B0332030
ELP/PFA 45 BOT	45 W/m	175°C	8.0 x 5.5	1.0	B0332045
ELP/PFA 60 BOT	60 W/m	160°C	8.0 x 5.5	1.0	B0332060

Bus wire cross section 2 x 2 mm² upon request.

Maximum heating circuit length

Type	W/m	Length (m) at 50 °C	Length (m) at 150 °C
ELP/PFA 15 BOT	15	161	119
ELP/PFA 30 BOT	30	98	82.5
ELP/PFA 45 BOT	45	65.5	65.5
ELP/PFA 60 BOT	60	50	50

Heating circuit lengths ELP/PFA on the following conditions

- 16 A circuit breaker, 80 % utilisation
- Max. 10 % voltage drop
- Power connection to one (1) heater end

Constant Wattage Heating Cable with Resistance Wire

These parallel heating cables offer tremendous flexibility in use, as they can easily be cut to the required length off the roll, with the assurance of constant power output. There is no need for a connecting cable and input can be unilateral. It is quick and easy to assemble; this saves a lot of time and as a result reduces cost considerably. Since output of up to 60 W/m is possible for lengths laid to piping, ELP parallel heating cables are particularly suitable for piping with high output requirements such as in industrial process technology. The particularly temperature-resistant outer shell and the high level of chemical resistance ensure a long useful life.

Advantages:

- Single end power input
- Can be cut off the roll
- Constant power output per meter
- Long life cycle
- Laying without exact measuring possible
- High chemical resistance
- UV resistance

Applications:

- Vessels, piping, valves
- Building construction
- Food processing industry
- Paper industry



Type ELP/FEP up to 200 °C

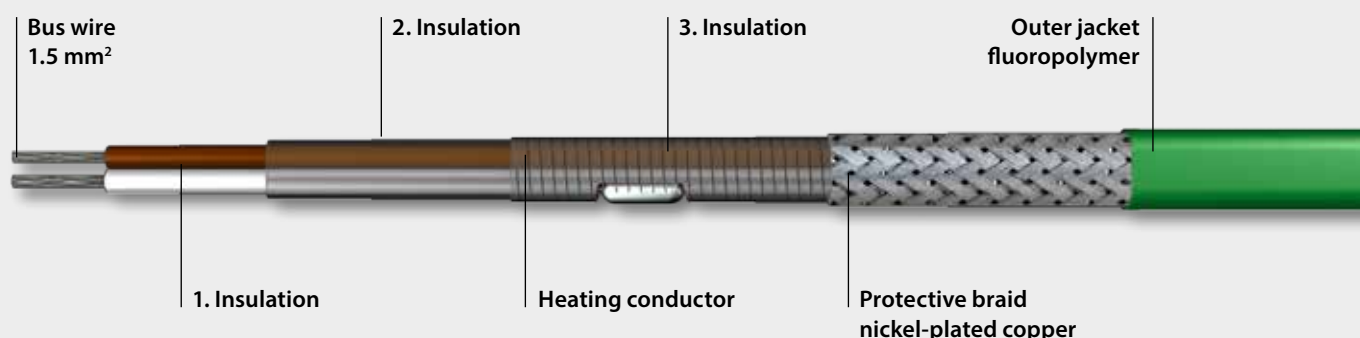



Technical Information

Type ELP/FEP up to 200 °C

Data

■ Insulation	Fluoropolymer
■ Protective braid	Nickel-plated copper
■ Outer jacket	Fluoropolymer
■ Nominal temperature	200 °C
■ Moisture proof	Yes
■ Bending radius, min.	25 mm
■ Bus wire cross section	2 x 1.5 mm ²
■ Nominal voltage	230 V AC/DC
■ Installation temp., min.	-45 °C
■ Start-up temp., min.	-45 °C

Standards

■ Manufactured according to	DIN VDE 0721-52 EN 62395-1; 2007-05
-----------------------------	--

Cables shall neither intersect nor contact.
Provide protection by means of circuit breaker FI 30.
Please observe the standards IEC 62395-2, EN 60519-10.

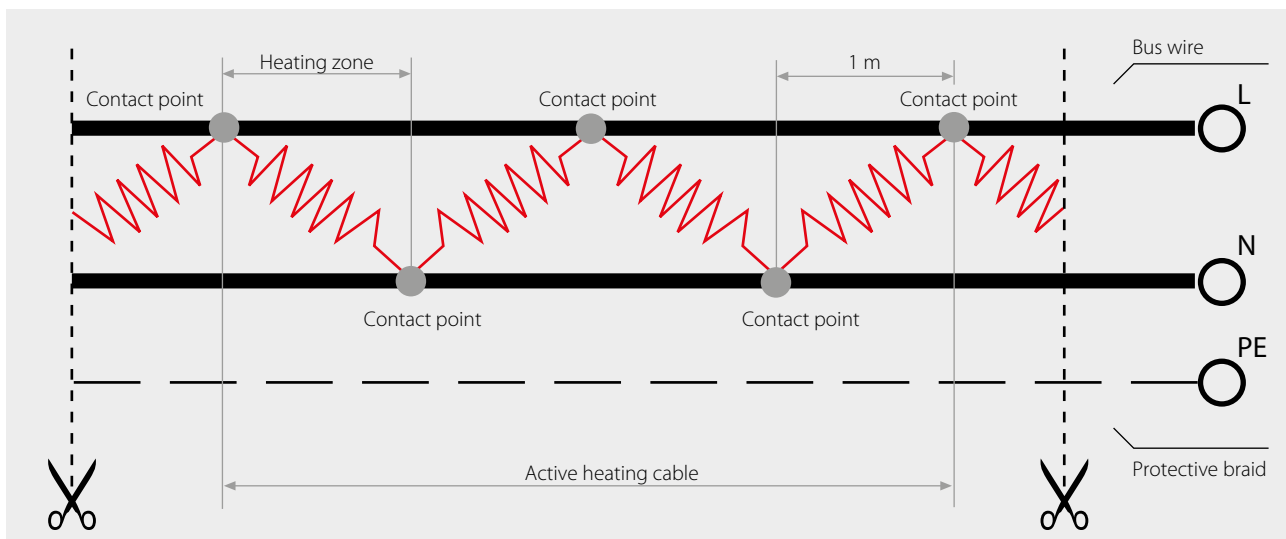

Type	Nominal output	Working temp. max	Dimensions approx. (mm)	Contact spacing (m)	Art. No.
ELP/FEP 15 BO	15 W/m	195°C	8.0 x 5.5	1.0	B033201501
ELP/FEP 30 BO	30 W/m	180°C	8.0 x 5.5	1.0	B033203001
ELP/FEP 45 BO	45 W/m	165°C	8.0 x 5.5	1.0	B033204501
ELP/FEP 60 BO	60 W/m	150°C	8.0 x 5.5	1.0	B033206001

Bus wire cross section 2 x 2 mm² upon request.

Maximum heating circuit length

Type	W/m	Length (m) at 50 °C	Length (m) at 150 °C
ELP/FEP 15 BO	15	161	119
ELP/FEP 30 BO	30	98	82.5
ELP/FEP 45 BO	45	65.5	65.5
ELP/FEP 60 BO	60	50	50

Heating circuit lengths ELP/FEP on the following conditions

- 16 A circuit breaker, 80 % utilisation
- Max. 10 % voltage drop
- Power connection to one (1) heater end

PTFE-insulated Heating Cable

Use on apparatus, vessels, pipes, valves, etc., in which low bending radii also allow compact tracing on small components across the entire surface.

Advantages:

- Highly flexible
- Small bending radius
- High operation temperature
- High chemical resistance
- Moisture proof

Applications:

- Vessels, pipes, valves
- Small components
- Can be used in many industrial areas
- Rotor blades
- Marble plates



Type **ELKM-A** up to 260 °C

Heating conductor
stranded or
spirally wound

Insulation
PTFE

Technical Information

Type ELKM-A up to 260 °C

Data

■ Insulation	PTFE
■ Nominal voltage max.	750 V
■ Output, max.	30 W/m*
■ Operating temp., max.	260 °C
■ Bending radius, min.	2.5 x outer diameter
■ Installation temp., min.	-60 °C
■ Moisture proof	Yes
■ Heat conductor	Stranded, spirally wound for nominal resistance > 8,000 Ω/km

Standards

■ Manufactured according to	DIN VDE 0253
-----------------------------	--------------

*Note: The output per meter of heating cable and the maximum possible operating temperatures depend on the respective application. For individual cases, we recommend that you contact our engineers – we will be pleased to advise you.

Nominal resistance Ω/km	Outer diameter approx. (mm)	Weight approx. (g/m)	Temperature coefficient (x 10 ⁻³ /K)	Art. No.
1.95	5.8	112	4.30	0136002
2.90	4.6	73	4.30	0136006
4.40	4.2	54	4.30	0136004
7.20	3.1	33	4.30	0136007
10.00	3.0	31	4.30	0136008
11.70	2.7	30	4.30	0136010
15.00	2.6	19	4.30	0136012
25.00	2.5	17	3.00	0136016
31.50	2.9	23	1.60	0136020
50.00	2.6	17	1.60	0136030
65.00	2.4	14	1.60	0136032
80.00	2.7	20	0.90	0136038
100.00	2.5	17	0.90	0136042
157.00	2.5	17	0.45	0136049
180.00	2.2	12	0.90	0136052
200.00	2.4	14	0.45	0136054
260.00	2.2	12	0.45	0136058

Weight tolerances are possible for manufacturing reasons.
Nominal resistances up to 1,500,000 Ω/km upon request.
Resistance tolerance: +/- 5 %.

Nominal resistance Ω/km	Outer diameter approx. (mm)	Weight approx. (g/m)	Temperature coefficient (x 10 ⁻³ /K)	Art. No.
280.00	2.1	10	0.38	0136059
328.00	2.5	16	0.18	0136061
360.00	2.1	10	0.45	0136064
430.00	2.3	13	0.18	0136066
480.00	2.2	12	0.18	0136068
600.00	2.1	10	0.18	0136076
800.00	2.0	9	0.18	0136080
1000.00	2.1	10	0.04	0136082
1470.00	2.1	9	0.04	0136092
1750.00	2.0	8	0.04	0136094
1900.00	2.2	12	0.04	0136096
2900.00	2.1	9	0.04	0136104
4000.00	2.0	8	0.04	0136114
4700.00	1.9	8	0.15	0136118
6000.00	1.9	7	0.20	0136124
7000.00	2.0	7	0.15	0136126
8000.00	2.0	7	0.15	0136128

For applications with fixed external diameter, please contact our engineers first.

Cables shall neither intersect nor contact.
Provide protection by means of circuit breaker FI 30.
Please observe the standards IEC 62395-2, EN 60519-10.

PTFE-insulated Heating Cable with Protective Braid Cu/Ni

Use on apparatus, vessels, pipes, valves, etc., in which low bending radii also allow compact tracing on small components across the entire surface. We recommend our heating cable ELKM-AE with protective braid AE for unprotected use in corrosive environment.

This heating cable is also available without braid under the name ELKM-A – just ask us.

Advantages:

- Highly flexible
- Small bending radius
- High operation temperature
- High chemical resistance
- Moisture proof

Applications:

- Vessels, pipes, valves
- Small components
- Can be used in many industrial areas
- Rotor blades
- Marble plates



Type **ELKM-AS** up to 260 °C

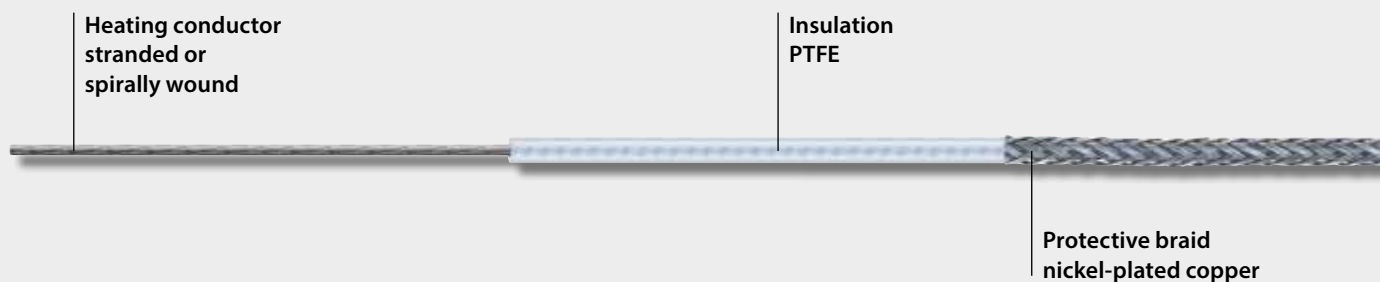

Technical Information

Type ELKM-AS up to 260 °C

Data

■ Insulation	PTFE
■ Protective braid	Nickel-plated copper
■ Nominal voltage max.	750 V
■ Output, max.	30 W/m*
■ Operating temp., max.	260 °C
■ Bending radius, min.	2.5 x outer diameter
■ Installation temp., min.	-60 °C
■ Moisture proof	Yes
■ Heat conductor	Stranded, spirally wound for nominal resistance > 8,000 Ω/km

Standards

■ Manufactured according to	DIN VDE 0253
-----------------------------	--------------

***Note:** The output per meter of heating cable and the maximum possible operating temperatures depend on the respective application. For individual cases, we recommend that you contact our engineers – we will be pleased to advise you.

Nominal resistance Ω/km	Outer diameter approx. (mm)	Weight approx. (g/m)	Temperature coefficient (x 10 ⁻³ /K)	Art. No.
1.95 (Cu 10 mm ²)	7.11	157.0	4.30	0137000
2.90 (Cu 6 mm ²)	5.99	104.9	4.30	0137002
4.40 (Cu 4 mm ²)	4.73	69.8	4.30	0137004
7.20 (Cu 2.5 mm ²)	3.89	48.3	4.30	0137007
10.00	3.62	40.6	4.30	0137009
11.70 (Cu 1.5 mm ²)	3.53	37.6	4.30	0137010
15.00	3.20	33.6	4.30	0137012
25.00	3.15	31.1	3.00	0137016
31.50	3.55	38.6	1.60	0137020
50.00	3.15	31.3	1.60	0137030
65.00	3.04	28.6	1.60	0137032
80.00	3.32	34.5	0.90	0137038
100.00	3.11	31.0	0.90	0137042
157.00	3.10	31.2	0.45	0137045
180.00	2.84	25.8	0.90	0137052
200.00	2.98	28.2	0.45	0137054
260.00	2.87	26.3	0.45	0137058

Weight tolerances are possible for manufacturing reasons. Nominal resistances up to 1,500,000 Ω/km upon request. Resistance tolerance: +/- 5 %.

Nominal resistance Ω/km	Outer diameter approx. (mm)	Weight approx. (g/m)	Temperature coefficient (x 10 ⁻³ /K)	Art. No.
280.00	2.76	24.3	0.38	0137060
328.00	3.13	30.6	0.18	0137061
360.00	2.71	23.7	0.45	0137064
430.00	2.96	27.6	0.18	0137266
480.00	2.94	26.8	0.18	0137069
600.00	2.80	24.9	0.18	0137213
800.00	2.69	23.2	0.18	0137080
1000.00	2.81	24.9	0.04	0137082
1470.00	2.64	22.6	0.04	0137214
1750.00	2.66	22.3	0.04	0137094
1900.00	2.84	25.6	0.40	0137215
2900.00	2.68	23.1	0.40	0137219
4000.00	2.61	21.9	0.40	0137114
4700.00	2.55	21.6	0.15	0137118
6000.00	2.49	20.6	0.20	0137237
7000.00	2.43	19.9	0.15	0137126
8000.00	2.41	19.7	0.15	0137128

For applications with fixed external diameter, please contact our engineers first.

Cables shall neither intersect nor contact. Provide protection by means of circuit breaker FI 30. Please observe the standards IEC 62395-2, EN 60519-10.

PTFE-insulated Heating Cable with Protective Braid VA

Use on apparatus, vessels, pipes, valves, etc., in which low bending radii also allow compact tracing on small components across the entire surface.

This heating cable is also available without braid under the name ELKM-A – just ask us.

Advantages:

- Highly flexible
- Small bending radius
- High operation temperature
- High chemical resistance
- Moisture proof

Applications:

- Vessels, pipes, valves
- Small components
- Industrial applications
- Heat tracing on molds
- Heat tracing on antenna
- IBC's



Type **ELKM-AE** up to 260 °C

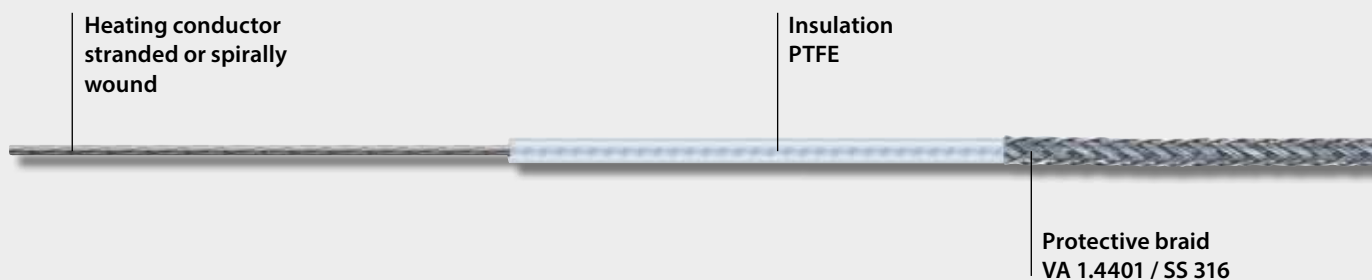

Technical Information

Type ELKM-AE up to 260 °C

Data

■ Insulation	PTFE
■ Protective braid	VA 1.4401 / SS 316
■ Nominal voltage max.	750 V
■ Output, max.	30 W/m*
■ Operating temp., max.	260 °C
■ Bending radius, min.	2.5 x outer diameter
■ Installation temp., min.	-60 °C
■ Moisture proof	Yes
■ Heat conductor	Stranded, spirally wound for nominal resistance > 8,000 Ω/km

Standards

■ Manufactured according to	DIN VDE 0253
-----------------------------	--------------

***Note:** The output per meter of heating cable and the maximum possible operating temperatures depend on the respective application. For individual cases, we recommend that you contact our engineers – we will be pleased to advise you.

Nominal resistance Ω/km	outer diameter approx. (mm)	Weight approx. (g/m)	Temperature coefficient (x 10 ⁻³ /K)	Art. No.
1.95 (Cu 10 mm ²)	6.97	130	4.30	0137001
2.90 (Cu 6 mm ²)	5.83	100	4.30	0137003
4.40 (Cu 4 mm ²)	4.57	70	4.30	0137005
7.20 (Cu 2.5 mm ²)	3.73	50	4.30	0137006
10.00	3.46	30	4.30	0137008
11.70 (Cu 1.5 mm ²)	3.37	30	4.30	0137011
15.00	3.04	30	4.30	0137013
25.00	2.99	30	3.00	0137017
31.50	3.39	30	1.60	0137021
50.00	2.90	22.2	1.60	0137031
65.00	2.88	19.6	1.60	0137033
80.00	3.16	25.4	0.90	0137039
100.00	2.95	22.0	0.90	0137043
157.00	2.94	22.1	0.45	0137044
180.00	2.68	17.0	0.90	0137053
200.00	2.82	19.3	0.45	0137055
260.00	2.71	17.4	0.45	0137059

Weight tolerances are possible for manufacturing reasons. Nominal resistances up to 1,500,000 Ω/km upon request. Resistance tolerance: +/- 5 %.

Nominal resistance Ω/km	outer diameter approx. (mm)	Weight approx. (g/m)	Temperature coefficient (x 10 ⁻³ /K)	Art. No.
280.00	2.60	15.6	0.38	0137230
328.00	2.97	21.5	0.18	0137231
360.00	2.55	14.9	0.45	0137065
430.00	2.80	18.7	0.18	0137067
480.00	2.78	17.9	0.18	0137068
600.00	2.64	16.1	0.18	0137232
800.00	2.53	14.5	0.18	0137081
1000.00	2.65	16.2	0.04	0137083
1470.00	2.48	13.9	0.04	0137233
1750.00	2.50	13.6	0.04	0137234
1900.00	2.68	11.6	0.40	0137235
2900.00	2.52	14.4	0.40	0137104
4000.00	2.45	13.3	0.40	0137115
4700.00	2.39	12.6	0.15	0137119
6000.00	2.33	12.0	0.20	0137236
7000.00	2.27	11.4	0.15	0137127
8000.00	2.25	11.1	0.15	0137121

For applications with fixed external diameter, please contact our engineers first.

Cables shall neither intersect nor contact. Provide protection by means of circuit breaker FI 30. Please observe the standards IEC 62395-2, EN 60519-10.

PTFE-insulated Heating Cable

with Protective Braid + Outer Jacket

This versatile, factory terminated, heating cable is used for frost protection and temperature maintenance, even under highly corrosive environmental conditions which means this heating cable can be used for an extremely wide variety of applications.

Advantages:

- Factory terminated
- High chemical and mechanical resistance
- Can be used in all industrial areas
- High operation temperature
- Easy to install, even on complex shapes
- Highly flexible
- Resistant to steam purging

Applications: e.g.

- Heat tracing on tanks
- Heat tracing on vessels
- Heat tracing on filters
- Heating satellite dishes
- Heat tracing on hoppers
- Pipe, valve and pump heating
- Automotive
- Tank containers
- IBC's
- Heating hoods



Type **ELKM-AG-L** up to 260°C

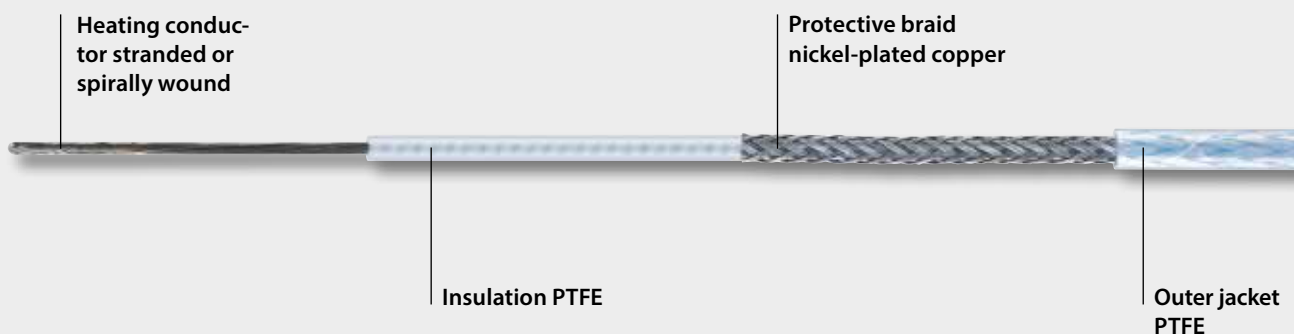



Technical Information

Type ELKM-AG-L up to 260 °C

Data

■ Insulation	PTFE
■ Protective braid	Nickel-plated copper
■ Outer jacket	PTFE
■ Nominal voltage max.	750 V
■ Output, max.	30 W/m*
■ Operating temp., max.	260 °C
■ Bending radius, min.	2.5 x outer diameter
■ Installation temp., min.	Up to -60 °C
■ Moisture proof	Yes
■ Heat conductor	Stranded, spirally wound for nominal resistance > 8,000 Ω/km

Standards

■ Manufactured according to	DIN VDE 0253
-----------------------------	--------------

***Note:** The output per meter of heating cable and the maximum possible operating temperatures depend on the respective application. For individual cases, we recommend that you contact our engineers – we will be pleased to advise you.

Nominal resistance (Ω/km)	Outer diameter approx. (mm)	Weight approx. (g/m)	Temperature coefficient (x 10 ⁻³ / K)	Art. No.
1.95 (Cu 10 mm ²)	7.7	156	4.30	01TT002E
2.90 (Cu 6 mm ²)	6.4	110	4.30	01TT003E
4.40 (Cu 4 mm ²)	5.6	85	4.30	01TT004E
7.20 (Cu 2.5 mm ²)	4.5	53	4.30	01TT007E
10.00	4.2	51	4.30	01TT010E
11.70 (Cu 1.5 mm ²)	4.1	48	4.30	01TT011E
15.00	3.9	44	4.30	01TT015E
25.00	3.8	43	3.00	01TT025E
31.50	4.1	45	1.60	01TT031E
50.00	3.8	43	1.60	01TT050E
65.00	3.6	42	1.60	01TT065E
80.00	3.9	55	0.90	01TT080E
100.00	3.8	53	0.90	01TT110E
157.00	3.8	40	0.45	01TT115E
180.00	3.5	38	0.90	01TT118E
200.00	3.6	39	0.45	01TT120E
260.00	3.5	38	0.45	01TT126E

Nominal resistance (Ω/km)	Outer diameter approx. (mm)	Weight approx. (g/m)	Temperature coefficient (x 10 ⁻³ / K)	Art. No.
280.00	3.4	35	0.38	01TT128E
328.00	3.78	35.2	0.45	01TT132E
360.00	3.3	33	0.45	01TT136E
430.00	3.5	38	0.18	01TT143E
480.00	3.5	39	0.18	01TT148E
600.00	3.4	35	0.18	01TT160E
800.00	3.3	34	0.18	01TT180E
1000.00	3.4	35	0.04	01TT210E
1470.00	3.2	40	0.04	01TT214E
1750.00	3.2	38	0.04	01TT217E
1900.00	3.5	39	0.40	01TT219E
2900.00	3.3	32	0.40	01TT229E
4000.00	3.2	31	0.40	01TT240E
4700.00	3.2	31	0.15	01TT247E
6000.00	3.2	38	0.20	01TT260E
7000.00	3.2	36	0.15	01TT270E
8000.00	3.2	33	0.15	01TT280E

Weight tolerances are possible for manufacturing reasons.
Nominal resistances up to 1,500,000 Ω/km upon request.
Resistance tolerance: +/- 5 %.

For applications with fixed external diameter, please contact our engineers first.

Cables shall neither intersect nor contact.
Provide protection by means of circuit breaker FI 30.
Please observe the standards IEC 62395-2, EN 60519-10.

PTFE-insulated Heating Cable

with Protective Braid + Outer Jacket

This versatile heating cable is used for frost protection and temperature maintenance, even under highly corrosive environmental conditions. The heating cable ELKM-AG-N is suited and approved for use in hazardous areas. It is highly flexible permitting its use in many fields of application.

Advantages:

- High chemical and mechanical resistance
- Can be used in all industrial areas
- High operation temperature
- Can be used in liquids
- Easy to install, even on complex shapes
- Highly flexible
- Resistant to steam purging

Applications, especially in Hazardous Areas: e.g.

- Heat tracing on tanks
- Heat tracing on vessels
- Heat tracing on filters
- Heat tracing on hoppers
- Pipe, valve and pump heating
- Tank containers
- IBC's
- Heating hoods
- Automotive
- Varnishing plants



Type **ELKM-AG-N** up to 260°C

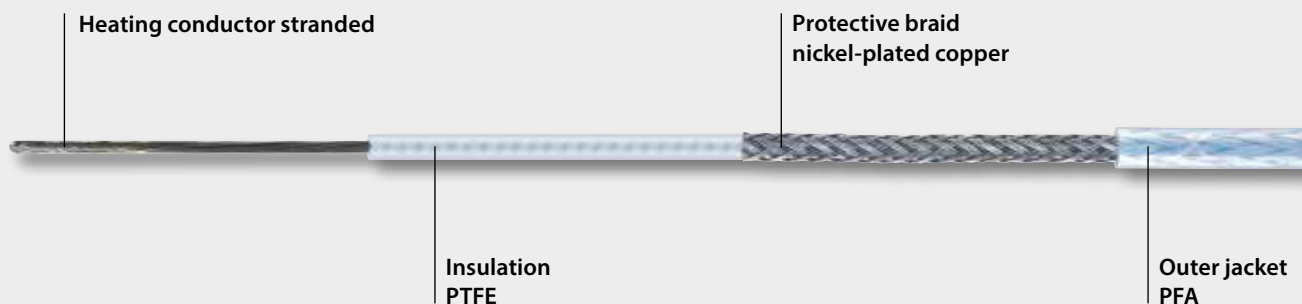



Technical Information

Type ELKM-AG-N up to 260 °C

Data

■ Insulation	PTFE
■ Protective braid	Nickel-plated copper
■ Outer jacket	PFA
■ Nominal voltage max.	550 V
■ Output, max.	30 W/m*
■ Operating temp., max.	260 °C
■ Bending radius, min.	2.5 x outer diameter
■ Installation temp., min.	-60 °C
■ Moisture proof	IP68
■ Impact resistance	4 Joule
■ Heat conductor	Stranded

Standards

■ Manufactured according to	DIN VDE 0253, EN 60079-30-1
■ Certificate	EPS 12ATEX1466U
■ Classification	II 2G Ex e IIC Gb II 2D Ex tb IIIC Db

***Note:** The output per meter of heating cable and the maximum possible operating temperatures depend on the respective application. For individual cases, we recommend that you contact our engineers – we will be pleased to advise you.

Nominal resistance (Ω/km)	Outer diameter approx. (mm)	Weight approx. (g/m)	Temperature coefficient (x 10 ⁻³ / K)	Art. No.
1.95 (Cu 10 mm ²)	8.1	166	4.30	01TA002E
2.90 (Cu 6 mm ²)	6.8	119	4.30	01TA003E
4.40 (Cu 4 mm ²)	6.1	96	4.30	01TA004E
7.20 (Cu 2.5 mm ²)	5.1	64	4.30	01TA007E
10.00	4.8	59	4.30	01TA010E
11.70 (Cu 1.5 mm ²)	4.7	57	4.30	01TA011E
15.00	4.5	50	4.30	01TA015E
25.00	4.4	48	3.00	01TA025E
31.50	4.7	56	1.60	01TA031E
50.00	4.4	49	1.60	01TA050E
65.00	4.2	46	1.60	01TA065E
80.00	4.5	42	0.90	01TA080E
100.00	4.4	50	0.90	01TA110E
157.00	4.4	46	0.45	01TA115E
180.00	4.1	42	0.90	01TA118E
200.00	4.2	38	0.45	01TA120E
260.00	4.1	42	0.45	01TA126E

Nominal resistance (Ω/km)	Outer diameter approx. (mm)	Weight approx. (g/m)	Temperature coefficient (x 10 ⁻³ / K)	Art. No.
280.00	4.0	39	0.38	01TA128E
328.00	4.1	40.1	0.45	01TA132E
360.00	3.9	40	0.45	01TA136E
430.00	4.1	43	0.18	01TA143E
480.00	4.1	44	0.18	01TA148E
600.00	4.0	40	0.18	01TA160E
800.00	3.9	41	0.18	01TA180E
1000.00	4.0	43	0.04	01TA210E
1470.00	3.8	40	0.04	01TA214E
1750.00	3.8	37	0.04	01TA217E
1900.00	3.5	41	0.40	01TA219E
2900.00	3.9	41	0.40	01TA229E
4000.00	3.8	37	0.40	01TA240E
4700.00	3.8	35	0.15	01TA247E
6000.00	3.8	34	0.20	01TA260E
7000.00	3.8	33	0.15	01TA270E
8000.00	3.8	36	0.15	01TA280E

Weight tolerances are possible for manufacturing reasons. Nominal resistances up to 1,500,000 Ω/km upon request. Resistance tolerance: +/- 5 %.

For applications with fixed external diameter, please contact our engineers first.

Cables shall neither intersect nor contact. Provide protection by means of circuit breaker FI 30mA. Please observe the standards EN 60079-30-2, EN 60519-10.

PTFE-insulated Heating Cable

Factory Terminated

Use on apparatus, vessels, pipes, valves, etc., in which low bending radii also allow compact tracing on small components across the entire surface.

The version with protective braid, nickel-plated copper, is available with the name ELK-AS. A version without protective braid is also available: ELK-A – just ask us.

Advantages:

- Factory terminated
- Highly flexible
- Small bending radius
- High operating temperature
- High chemical resistance
- Moisture proof

Applications:

- Vessels, pipes, valves
- Small components
- Can be used in many industrial areas
- Heat tracing on molds
- Heat tracing on satellite dishes
- IBC's



Type **ELK-AE** up to 260 °C

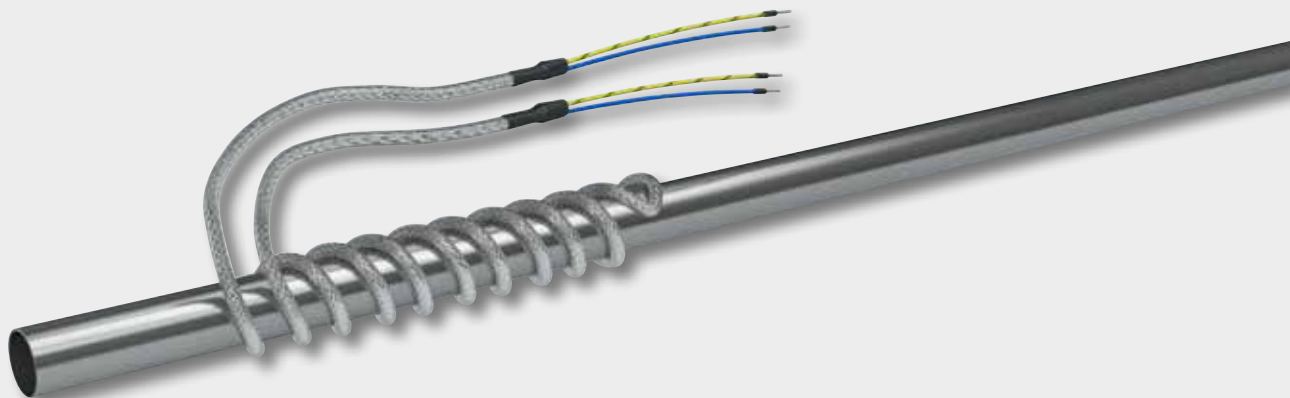



Technical Information

Type ELK-AE up to 260 °C

Data

■ Insulation	PTFE
■ Protective braid	VA 1.4401 / SS 316
■ Nominal voltage max.	230 V
■ Output, max.	25 W/m
■ Operating temp., max.	260 °C
■ Heating conductor diameter	3.1 - 3.6 mm
■ Bending radius, min.	2.5 x outer diameter
■ Installation temp., min.	-60 °C
■ Cold lead length, both ends	1.2 m, without plug
■ Moisture proof	Yes
■ Protection class	I

Standards

■ Manufactured according to	DIN VDE 0253
■ Final inspection according to	DIN VDE 0721 T 411 2.5 kV AC - 1 min EN 62395-1

***Note:** The output per meter of heating cable and the maximum possible operating temperatures depend on the respective application. For individual cases, we recommend that you contact our engineers – we will be pleased to advise you.

Designation	Heated length (m)	Nominal output (W) temperature. max. 100 °C	Art. No.	Nominal output (W) temperature. max. 150 °C	Art. No.	Nominal output (W) temperature. max. 200 °C	Art. No.
ELK-AE 1.2	1.2	30	0133011	–	–	–	–
ELK-AE 2.2	2.2	54	0133021	–	–	–	–
ELK-AE 3.4	3.4	78	0133031	52	0133032	26	0133033
ELK-AE 4.8	4.8	94	0133041	69	0133042	37	0133043
ELK-AE 6.0	6.0	147	0133061	88	0133062	44	0133063
ELK-AE 8.4	8.4	210	0133081	126	0133082	63	0133083
ELK-AE 10.8	10.8	245	0133101	163	0133102	82	0133103
ELK-AE 12.0	12.0	294	0133121	176	0133122	88	0133123
ELK-AE 14.0	14.0	344	0133141	–	–	–	–
ELK-AE 20.0	20.0	464	0133201	294	0133202	–	–
ELK-AE 25.0	25.0	623	0133251	371	0133252	192	0133253
ELK-AE 30.0	30.0	705	0133301	441	0133302	220	0133303
ELK-AE 35.0	35.0	864	0133351	521	0133352	–	–
ELK-AE 42.0	42.0	1.008	0133421	611	0133422	315	0133423
ELK-AE 56.0	56.0	1.390	0133561	756	0133562	378	0133563

Other lengths upon request.
Resistance tolerance: +/- 5 %
All output figures are nominal values at +20 °C.
Lengths tolerance ± 2%, max. ± 0.25 m.

For applications with fixed external diameter, please contact our engineers first.

Cables shall neither intersect nor contact.
Provide protection by means of circuit breaker FI 30.
Please observe the standards IEC 62395-2, EN 60519-10.

PTFE-insulated Heating Cable

Factory Terminated

This versatile, factory terminated, heating cable is used for frost protection and temperature maintenance, even under highly corrosive environmental conditions which means this heating cable can be used on an extremely wide variety of applications.

Advantages:

- Factory terminated
- High chemical and mechanical resistance
- Can be used in all industrial areas
- High operating temp.
- Can be used in liquids
- Easy to install, even on complex shapes
- Highly flexible
- Resistant to steam purging

Applications: e.g.

- Heat tracing on tanks
- Heat tracing on vessels
- Heat tracing on filters
- Heat tracing on satellite dishes
- Heat tracing on hoppers
- Pipes, valves and pumps
- Automotive
- Tank containers
- IBC's
- Heating hoods



Type **ELK-AG-L** up to 260 °C

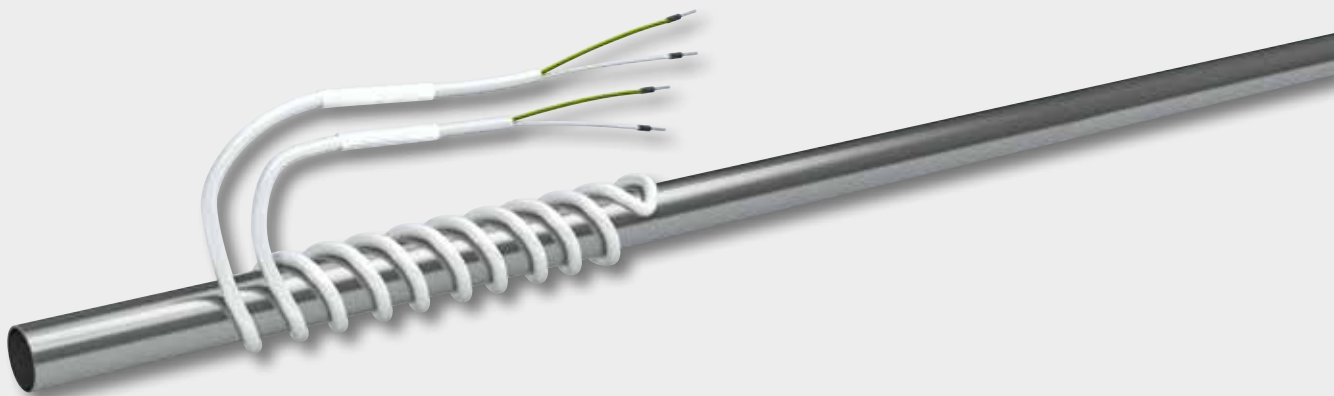



Technical Information

Type ELK-AG-L up to 260 °C

Data

■ Insulation	PTFE
■ Protective braid	Nickel-plated copper
■ Outer jacket	PTFE
■ Nominal voltage max.	230 V
■ Output	25 W/m
■ Operating temp., max.	260 °C
■ Heating conductor diameter	4.1 - 4.8 mm
■ Bending radius, min.	2.5 x outer diameter
■ Cold lead length, both ends	1.2 m, without plug
■ Installation temp., min.	-60 °C
■ Moisture proof	Yes
■ Protection class	I

Standards

■ Manufactured according to	DIN VDE 0253, EN 62395-1
■ VDE mark approval	40001594

***Note:** The output per meter of heating cable and the maximum possible operating temperatures depend on the respective application. For individual cases, we recommend that you contact our engineers – we will be pleased to advise you.

Designation	Heated length (m)	Nominal output (W) temperature. max. 100 °C	Art. No.	Nominal output (W) temperature. max. 150 °C	Art. No.	Nominal output (W) temperature. max. 200 °C	Art. No.
ELK-AG-L 1.2	1.2	30	0135011				
ELK-AG-L 2.2	2.2	54	0135021				
ELK-AG-L 3.4	3.4	78	0135031	52	0135032	26	0135033
ELK-AG-L 4.8	4.8	94	0135041	69	0135042	37	0135043
ELK-AG-L 6.0	6.0	147	0135061	88	0135062	44	0135063
ELK-AG-L 8.4	8.4	210	0135081	126	0135082	63	0135083
ELK-AG-L 10.8	10.8	245	0135101	163	0135102	82	0135103
ELK-AG-L 12.0	12.0	294	0135121	176	0135122	88	0135123
ELK-AG-L 14.0	14.0	344	0135141				
ELK-AG-L 20	20.0	464	0135201	294	0135202		
ELK-AG-L 25	25.0	623	0135251	371	0135252	192	0135253
ELK-AG-L 30	30.0	705	0135301	441	0135302	220	0135303
ELK-AG-L 35	35.0	864	0135351	521	0135352		
ELK-AG-L 42.0	42.0	1,008	0135421	611	0135422	315	0135423
ELK-AG-L 56.0	56.0	1,390	0135561	756	0135562	378	0135563

Other lengths upon request.

Resistance tolerance: +/- 5 %

All output figures are nominal values at +20 °C.

Lengths tolerance ± 2%, max. ± 0.25 m.

For applications with fixed external diameter, please contact our engineers first.

Cables shall neither intersect nor contact.

Provide protection by means of circuit breaker FI 30.

Please observe the standards IEC 62395-2, EN 60519-10.

PTFE-insulated Heating Cable

Factory Terminated

This versatile heating cable is used for frost protection and temperature maintenance, even under highly corrosive environmental conditions. The heating cable ELK-AG-N is suited and approved for use in potentially explosive atmospheres. It is highly flexible permitting its application in areas of use. Upon consultation of our engineers, this cable may likewise be used for inside trace heating of piping.

Advantages:

- Factory terminated
- High chemical and mechanical resistance
- Can be used in all industrial areas
- High operating temp.
- Can be used in liquids
- Easy to install, even on complex shapes
- Highly flexible
- Resistant to steam purging

Applications, especially in Hazardous Areas: e.g.

- Heat tracing on tanks
- Heat tracing on vessels
- Heat tracing on filters
- Heat tracing on hoppers
- Pipes, valves and pumps
- Tank containers
- IBC's
- Heating hoods
- Automotive
- Varnishing plants



Type **ELK-AG-N** up to 260 °C

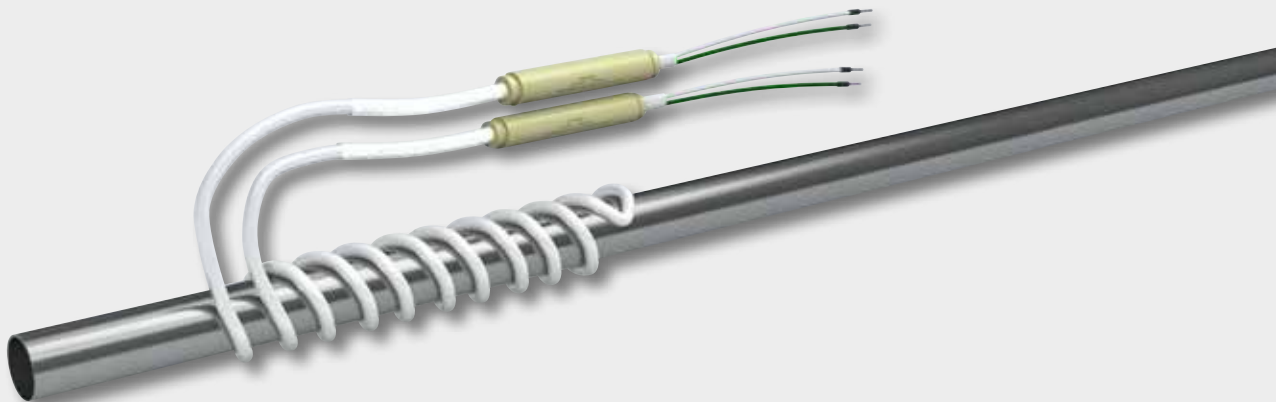



Technical Information

Type ELK-AG-N up to 260 °C

Data

■ Insulation	PTFE
■ Protective braid	Nickel-plated copper
■ Outer jacket	PFA
■ Nominal voltage max.	230 V
■ Output	25 W/m
■ Operating temp., max.	260 °C
■ Heating conductor diameter	3.8 - 4.7 mm
■ Bending radius, min.	2.5 x outer diameter
■ Installation temp., min.	-60 °C
■ Cold lead length, both ends	1.2 m, without plug
■ Moisture proof	Yes
■ Protection class	I
■ Impact resistance	4 Joule

Standards

■ Manufactured according to	DIN VDE 0253, EN 60079-30-1
■ Cable	60079-30-1
■ Pipe collar	60079-0-7
For Ex-applications:	
■ Classification cable	II 2G Ex e IIC Gb II 2D Ex tb IIIC Db
■ Certificate cable	EPS 12ATEX1466U
■ Classification ExCon	II 2G Ex e IIC T6...T3 Gb II 2D Ex tb IIIC TX Db
■ Certificate ExCon	04ATEX1005X / 07ATEX1023X
■ Standard ExCon	EN 60079-0:2009, EN 60079-7:2007, EN 60079-31:2009

***Note:** The output per meter of heating cable and the maximum possible operating temperatures depend on the respective application. For individual cases, we recommend that you contact our engineers – we will be pleased to advise you.

Heating Tape

for Sensitive Surfaces

The factory terminated heating tape ELW-GN with E-glass insulation is suitable for trace heating of apparatus, appliances and systems in a non-corrosive environment and its preferred use is for glass devices and systems with sensitive surfaces.

Advantages:

- Factory terminated
- Single end connection
- Highly flexible
- Surface-friendly
- Small bending radius
- Easy to assemble
- Moisture proof

Applications:

- Heat tracing on apparatus, appliances and systems
- Devices and systems made of glass with sensitive surfaces
- Laboratory applications



Type **ELW-GN** up to 260 °C



Technical Information

Type ELW-GN up to 260 °C

Data

■ Insulation (1)	PTFE
■ Protective braid (2)	Nickel-plated copper
■ Outer jacket (3)	E-glass textile
■ Nominal voltage	230 V
■ Output	Approx. 50 W/m*
■ Operating temp., max.	260 °C
■ Dimensions (wxh)	Approx. 25 x 6 mm
■ Bending radius, flat, min.	10 mm
■ Installation temp., min.	-60 °C
■ Moisture proof	Yes
■ Cold lead length, both ends	1.2 m, without plug
■ Protection class	I

Standards

■ Manufactured according to	DIN VDE 0253
■ Final inspection according to	DIN VDE 0721 T411 2.5 kV AC – 1 min

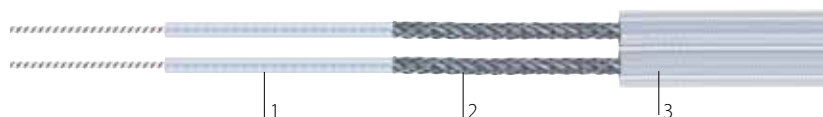

***Note:** The output per meter of heating cable and the maximum possible operating temperatures depend on the respective application. For individual cases, we recommend that you contact our engineers – we will be pleased to advise you.

Designation	Heated length (m)	Nominal output (W) temperature. max. 100 °C	Art. No.	Nominal output (W) temperature. max. 150 °C	Art. No.	Nominal output (W) temperature. max. 200 °C	Art. No.
ELW-GN 0.6	0.6	30	0231001	–		–	
ELW-GN 1.1	1.1	54	0231011	–		–	
ELW-GN 1.7	1.7	78	0231701	52	0231012	26	0231013
ELW-GN 2.4	2.4	94	0231021	69	0231022	37	0231023
ELW-GN 3.0	3.0	147	0231031	88	0231032	44	0231033
ELW-GN 4.2	4.2	210	0231041	126	0231042	63	0231043
ELW-GN 5.4	5.4	245	0231051	163	0231052	82	0231053
ELW-GN 6.0	6.0	294	0231061	176	0231062	88	0231063
ELW-GN 7.0	7.0	344	0231071	–		–	
ELW-GN 10.0	10.0	464	0231101	294	0231102	–	
ELW-GN 12.5	12.5	623	0231121	371	0231122	192	0231123
ELW-GN 15.0	15.0	705	0231151	441	0231152	220	0231153
ELW-GN 17.5	17.5	864	0231171	521	0231172	–	
ELW-GN 21.0	21.0	1,008	0231211	611	0231212	315	0231213
ELW-GN 28.0	28.0	1,390	0231281	756	0231282	378	0231283

Other lengths upon request.

Resistance tolerance: +/- 5 %

All output figures are nominal values at +20 °C.

Lengths tolerance ± 2%, max. ± 0.25 m.

Cables shall neither intersect nor contact.

Provide protection by means of circuit breaker FI 30.

Please observe the standards IEC 62395-2, EN 60519-10.

Heating Tape

for Corrosive Environments

The factory terminated heating tape ELW-VA is suitable for trace heating of apparatus, appliances and systems in a corrosive environment. The minimal dimensions of the heating tape enable close tracing. This heating tape is not sensitive to rough surfaces.

Advantages:

- Factory terminated
- Single end connection
- Highly flexible
- Small bending radius
- Small dimensions
- Robust
- Easy to assemble
- Moisture proof

Applications:

- Heat tracing on apparatus, appliances and systems
- Laboratory applications
- Temperature maintenance on piping



Type **ELW-VA** up to 260 °C



Technical Information

Data

■ Insulation (1)	PTFE
■ Protective braid (2)	1.4301 / SS 304
■ Nominal voltage	230 V
■ Output	Approx. 50 W/m*
■ Operating temp., max.	260 °C
■ Dimensions (wxh)	Approx. 10 x 5 mm
■ Dimensions, sleeve (wxhxl)	32 x 16 x 65 mm
■ Bending radius, flat, min.	15 mm
■ Installation temp., min.	-30 °C
■ Moisture proof	Yes
■ Cold lead length, both ends	1.2 m, silicone cable, without plug
■ Protection class	I

Standards

■ Manufactured according to	DIN VDE 0253
■ Final inspection according to	DIN VDE 0721 T411 2.5 kV AC – 1 min

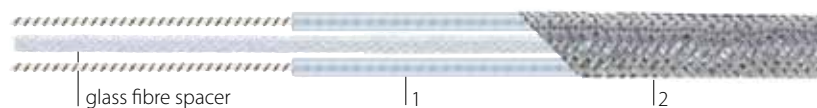

***Note:** The output per meter of heating cable and the maximum possible operating temperatures depend on the respective application. For individual cases, we recommend that you contact our engineers – we will be pleased to advise you.

Designation	Heated length (m)	Nominal output (W) temperature. max. 100 °C	Art. No.	Nominal output (W) temperature. max. 150 °C	Art. No.	Nominal output (W) temperature. max. 200 °C	Art. No.
ELW-VA 0.6	0.6	30	0232001	–		–	
ELW-VA 1.1	1.1	54	0232011	–		–	
ELW-VA 1.7	1.7	78	0232701	52	0232012	26	0232013
ELW-VA 2.4	2.4	94	0232021	69	0232022	37	0232023
ELW-VA 3.0	3.0	147	0232031	88	0232032	44	0232033
ELW-VA 4.2	4.2	210	0232041	126	0232042	63	0232043
ELW-VA 5.4	5.4	245	0232051	163	0232052	82	0232053
ELW-VA 6.0	6.0	294	0232061	176	0232062	88	0232063
ELW-VA 7.0	7.0	344	0232071	–		–	
ELW-VA 10.0	10.0	464	0232101	294	0232102	–	
ELW-VA 12.5	12.5	623	0232121	371	0232122	192	0232123
ELW-VA 15.0	15.0	705	0232151	441	0232152	220	0232153
ELW-VA 17.5	17.5	864	0232171	521	0232172	–	
ELW-VA 21.0	21.0	1,008	0232211	611	0232212	315	0232213
ELW-VA 28.0	28.0	1,390	0232281	756	0232282	378	0232283

Other lengths upon request.
Resistance tolerance: +/- 5 %
All output figures are nominal values at +20 °C.
Lengths tolerance ± 2%, max. ± 0.25 m.

Cables shall neither intersect nor contact.
Provide protection by means of circuit breaker FI 30.
Please observe the standards IEC 62395-2, EN 60519-10.

Heating Cable

for Maximum Flexibility

The factory terminated heating cable ELK-H is suitable for trace heating of apparatus, appliances and systems in a dry environment with protected installation. Both the high output and the slight, flexible design provide a wide variety of applications for this heating cable.

Advantages:

- Factory terminated
- Can be used for high temperatures
- Ready to be used instantly
- Highly flexible
- Small bending radius
- Easy to assemble

Applications:

- Heat tracing on apparatus, appliances and systems
- Glass devices and systems with high output needs
- Laboratory applications



Type **ELK-H** up to 450 °C





Technical Information

Type ELK-H up to 450 °C

Data

■ Insulation	E-glass textile
■ Nominal voltage	230 V
■ Output	approx. 125 W/m*
■ Operating temp., max.	450 °C
■ Diameter	3.5 - 4.5 mm
■ Bending radius, flat, min.	8 mm
■ Installation temp., min.	Not restricted
■ Moisture proof	No
■ Cold lead length	1.2 m, without plug
■ Protection class	Depending on installation

Standards

■ Manufactured according to	DIN VDE 0721 T2
■ Final inspection according to	DIN VDE 0721 T2 1.5 kV AC – 1 min

***Note:** The output per meter of heating cable and the maximum possible operating temperatures depend on the respective application. For individual cases, we recommend that you contact our engineers – we will be pleased to advise you.

Designation	Heated length (m)	Nominal output (W)	Art. No.
ELK-H-0.5	0.5	60	0140002
ELK-H-1.0	1.0	126	0140005
ELK-H-1.4	1.4	180	0140008
ELK-H-2.0	2.0	250	0140013
ELK-H-3.0	3.0	375	0140014
ELK-H-4.0	4.0	490	0140019

Not all resistances are available ex stock – please contact us.
Other lengths upon request.
Resistance tolerance: +/- 5 %
Lengths tolerance ± 2%, max. ± 0.25 m.

Designation	Heated length (m)	Nominal output (W)	Art. No.
ELK-H-5.0	5.0	622	0140020
ELK-H-6.5	6.5	768	0140024
ELK-H-8.0	8.0	987	0140025
ELK-H-10.0	10.0	1260	0140030
ELK-H-12.6	12.6	1555	0140031
ELK-H-16.0	16.0	1945	0140034

Cables shall neither intersect nor contact.
Provide protection by means of circuit breaker FI 30mA.
Please observe the standards EN 60519-1, EN 60519-2.

Heating Cable

Robust, for Higher Temperatures

This factory terminated heating cable is ideally suited for trace heating of apparatus, appliances and systems in a dry environment. Preferably used for appliances and systems with high output requirements. Small dimensions and high flexibility simplify the assembly. The outer braiding provides protection against mechanical damages and can be integrated in the electrical protection measures.

Advantages:

- Factory terminated
- Increased safety through protective braid
- High output
- Ready to be used instantly
- Highly flexible
- Can be used for higher temperatures
- Small bending radius
- Easy to assemble

Applications:

- Heat tracing on apparatus, appliances and systems
- Devices and systems with high output needs
- Laboratory applications



Type **ELK-HS** up to 450 °C



Technical Information

Type ELK-HS up to 450 °C

Data

■ Insulation	E-glass textile
■ Protective braid	1.4301 / SS 304
■ Nominal voltage	230 V
■ Output	Approx. 125 W/m*
■ Operating temp., max.	450 °C
■ Diameter	4.5 mm
■ Bending radius, min.	8 mm
■ Installation temp., min.	Not restricted
■ Moisture proof	No
■ Cold lead length	1.2 m, without plug
■ Protection class	I

Standards

■ Manufactured according to	DIN VDE 0721 T2
■ Final inspection according to	DIN VDE 0721 T2 1.5 kV AC – 1 min

***Note:** The output per meter of heating cable and the maximum possible operating temperatures depend on the respective application. For individual cases, we recommend that you contact our engineers – we will be pleased to advise you.

Designation	Heated length (m)	Nominal output (W)	Art. No.
ELK-HS-0.5	0.5	60	0140102
ELK-HS-1.0	1.0	126	0140105
ELK-HS-1.4	1.4	180	0140108
ELK-HS-2.0	2.0	250	0140113
ELK-HS-3.0	3.0	375	0140114
ELK-HS-4.0	4.0	490	0140119

Not all resistances are available ex stock – please contact us.
Other lengths upon request.
Resistance tolerance: +/- 5 %
Lengths tolerance ± 2%, max. ± 0.25 m.

Designation	Heated length (m)	Nominal output (W)	Art. No.
ELK-HS-5.0	5.0	622	0140120
ELK-HS-6.5	6.5	768	0140124
ELK-HS-8.0	8.0	987	0140125
ELK-HS-10.0	10.0	1260	0140131
ELK-HS-12.6	12.6	1555	0140134
ELK-HS-16.0	16.0	1945	0140137

Cables shall neither intersect nor contact.
Provide protection by means of circuit breaker FI 30.
Please observe the standards IEC 62395-2, EN 60519-10.

Heating Tape

for Maximum Flexibility

It is used to heat up glass, quartz or ceramic devices and systems in a non-corrosive and dry environment. The tape is highly flexible, does not damage the surfaces and is suitable for high output requirements. The heating tape should be protected mechanically and adjacent metallic parts should be integrated in the electrical protection measures.

Advantages:

- Factory terminated
- Ready to be used instantly
- Single end connection
- Can be used for high temperatures
- Highly flexible
- Surface-friendly
- Small bending radius
- Easy to assemble

Applications:

- Heat tracing on apparatus, appliances and systems made of glass, quartz or ceramic material
- Glass devices and systems with high output needs
- Laboratory & research applications



Type **ELW-H** up to 450 °C





Technical Information

Type ELW-H up to 450 °C

Data

■ Insulation (1)	E-glass textile
■ Outer jacket (2)	E-glass textile
■ Nominal voltage	230 V
■ Output	Approx. 250 W/m*
■ Operating temp., max.	450 °C
■ Dimensions	30 x 5 mm
■ Bending radius, flat, min.	10 mm
■ Installation temp., min.	Not restricted
■ Moisture proof	No
■ Connection	1.2 m, without plug
■ Protection class	Depending on installation

Standards

■ Manufactured according to	DIN VDE 0721 T2
■ Final inspection according to	DIN VDE 0721 T411 1.5 kV AC – 1 min



***Note:** The output per meter of heating cable and the maximum possible operating temperatures depend on the respective application. For individual cases, we recommend that you contact our engineers – we will be pleased to advise you.

Designation	Heated length (m)	Nominal output (W)	Art. No.
ELW-H-0.50	0.50	126	0240002
ELW-H-0.70	0.70	180	0240005
ELW-H-1.00	1.00	250	0240010
ELW-H-1.50	1.50	375	0240011
ELW-H-2.00	2.00	490	0240016
ELW-H-2.50	2.50	622	0240017

Not all resistances are available ex stock – please contact us.
Other lengths upon request.
Resistance tolerance: +/- 5 %
Lengths tolerance ± 2%, max. ± 0,25 m.

Designation	Heated length (m)	Nominal output (W)	Art. No.
ELW-H-3.25	3.25	768	0240021
ELW-H-4.00	4.00	987	0240025
ELW-H-5.00	5.00	1260	0240027
ELW-H-6.30	6.30	1555	0240031
ELW-H-8.00	8.00	1945	0240034

Cables shall neither intersect nor contact.
Provide protection by means of circuit breaker FI 30mA.
Please observe the standards EN 60519-1, EN 60519-2.

Heating Tape

Robust, for Higher Temperatures

This factory terminated heating cable is ideally suited for trace heating of apparatus, appliances and systems in a non-corrosive and dry environment. The heating tape is highly flexible, does not damage the surfaces and is suitable for high output requirements. The braiding provides protection against mechanical damages and can be integrated in the electrical protection measures.

Advantages:

- Factory terminated
- Ready to be used instantly
- Single end connection
- Increased safety through protective braid
- Can be used for higher temperatures
- Highly flexible
- Surface-friendly
- Small bending radius
- Easy to assemble

Applications:

- Heat tracing on apparatus, piping, valves and systems
- Devices and systems with high output needs
- Laboratory & research applications



Type **ELW-HS** up to 450 °C



Technical Information

Type ELW-HS up to 450 °C

Data

■ Insulation (1)	E-glass textile
■ Protective braid (2)	1.4301 / SS 304
■ Outer jacket (3)	E-glass textile
■ Nominal voltage	230 V
■ Output	Approx. 250 W/m*
■ Operating temp., max.	450 °C
■ Dimensions	30 x 5 mm
■ Bending radius, flat, min.	10 mm
■ Installation temp., min.	Not restricted
■ Moisture proof	No
■ Cold lead length, both ends	1.2 m, without plug
■ Protection class	I

Standards

■ Manufactured according to	DIN VDE 0721 T2
■ Final inspection according to	DIN VDE 0721 T411 1.5 kV AC – 1 min



***Note:** The output per meter of heating cable and the maximum possible operating temperatures depend on the respective application. For individual cases, we recommend that you contact our engineers – we will be pleased to advise you.

Designation	Heated length (m)	Nominal output (W)	Art. No.
ELW-HS-0.5	0.50	126	0240102
ELW-HS-0.7	0.70	180	0240105
ELW-HS-1.0	1.00	250	0240110
ELW-HS-1.5	1.50	375	0240111
ELW-HS-2.0	2.00	490	0240116
ELW-HS-2.5	2.50	622	0240117

Not all resistances are available ex stock – please contact us.
Other lengths upon request.
Resistance tolerance: +/- 5 %
Lengths tolerance ± 2%, max. ± 0,25 m.

Designation	Heated length (m)	Nominal output (W)	Art. No.
ELW-HS-3.25	3.25	768	0240121
ELW-HS-4.0	4.00	987	0240125
ELW-HS-5.0	5.00	1260	0240127
ELW-HS-6.3	6.30	1555	0240131
ELW-HS-8.0	8.00	1945	0240135

Cables shall neither intersect nor contact.
Provide protection by means of circuit breaker FI 30.
Please observe the standards IEC 62395-2, EN 60519-10.

Heating Cable

for Highest Output

The preferred use of the heating cable is for glass, quartz or ceramic devices and systems with the highest output requirements in a dry environment. Small dimensions and high flexibility simplify assembly. The heating cable must be installed touch-protected. If you plan to use the heating cable on metal and at an operating temperature in excess of 650 °C, please consult our project engineers.

Advantages:

- Factory terminated
- Highest output
- Highest operating temperatures
- Ready to be used instantly
- Highly flexible
- Small bending radius
- Surface-friendly

Applications:

- Heat tracing on glass, quartz and ceramic devices
- Devices and systems with high output needs
- Laboratory & research applications



Type **ELK-Q** up to 900 °C





Technical Information

Type ELK-Q up to 900 °C

Data

■ Insulation	Quartz textile
■ Nominal voltage	230 V
■ Output	~ 175 W/m*
■ Operating temp., max.	900 °C
■ Diameter	Approx. 4 mm
■ Bending radius, min.	5 x outer diameter
■ Installation temp., min.	Not restricted
■ Moisture proof	No
■ Cold lead length	1.2 m, without plug
■ Protection class	Depending on installation

Standards

■ Manufactured according to	DIN VDE 0721 T2
■ Final inspection according to	DIN VDE 0721 T2 1.5 kV AC – 1 min

***Note:** The output per meter of heating cable and the maximum possible operating temperatures depend on the respective application. For individual cases, we recommend that you contact our engineers – we will be pleased to advise you.

Designation	Heated length (m)	Nominal output (W)	Art. No.
ELK-Q 0.6	0.6	106	0160003
ELK-Q 1.0	1.2	138	0160006
ELK-Q 1.4	1.4	270	0160007
ELK-Q 2.0	2.0	319	0160011
ELK-Q 3.1	3.1	533	0160014

Not all resistances are available ex stock – please contact us.
Other lengths upon request.
Resistance tolerance: +/- 5 %
Lengths tolerance ± 2%, max. ± 0.25 m.

Designation	Heated length (m)	Nominal output (W)	Art. No.
ELK-Q 4.0	4.0	696	0160017
ELK-Q 5.0	5.0	882	0160020
ELK-Q 6.0	6.0	1062	0160023
ELK-Q 8.0	8.0	1438	0160026
ELK-Q 10.0	10.0	1653	0160029

Cables shall neither intersect nor contact.
Provide protection by means of circuit breaker FI 30.
Please observe the standards IEC 62395-2, EN 60519-10.

Heating Tape

for Highest Output

The preferred use of the heating cable is for glass, quartz or ceramic devices and systems with the highest output requirements in a dry environment. Single end connection and high flexibility simplify assembly. The heating tape must be installed touch-protected. If you plan to use the heating cable on metal and at an operating temperature in excess of 650 °C, please consult our project engineers.

Advantages:

- Factory terminated
- Highest output
- Highest operating temperatures
- Ready to be used instantly
- Highly flexible
- Small bending radius
- Surface-friendly
- Single end connection

Applications:

- Heat tracing on glass, quartz and ceramic devices
- Devices and systems with highest output needs
- Laboratory & research applications



Type **ELW-Q** up to 900 °C



Technical Information

Type ELW-Q up to 900 °C

Data

■ Insulation (1)	Quartz textile
■ Outer jacket (2)	Quartz textile
■ Nominal voltage	230 V
■ Output	350 W/m*
■ Operating temp., max.	900 °C
■ Dimensions (wxh)	Approx. 35 x 6 mm
■ Bending radius, flat, min.	20 mm
■ Installation temp., min.	Not restricted
■ Moisture proof	No
■ Cold lead length	1.2 m, without plug

Standards

■ Manufactured according to	DIN VDE 0721 T2
■ Final inspection according to	DIN VDE 0721 T2 1.5 kV AC – 1 min

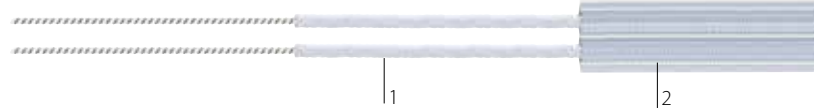

***Note:** The output per meter of heating cable and the maximum possible operating temperatures depend on the respective application. For individual cases, we recommend that you contact our engineers – we will be pleased to advise you.

Designation	Heated length (m)	Nominal output (W)	Art. No.
ELW-Q 0.6	0.60	138	0260003
ELW-Q 0.7	0.70	270	0260005
ELW-Q 1.0	1.00	319	0260008
ELW-Q 1.5	1.55	533	0260012
ELW-Q 2.0	2.00	696	0260014

Not all resistances are available ex stock – please contact us.
Other lengths upon request.
Resistance tolerance: +/- 5 %
Lengths tolerance ± 2%, max. ± 0.25 m.

Designation	Heated length (m)	Nominal output (W)	Art. No.
ELW-Q 2.5	2.50	882	0260017
ELW-Q 3.0	3.00	1062	0260020
ELW-Q 4.0	4.00	1438	0260023
ELW-Q 5.0	5.00	1653	0260026

Cables shall neither intersect nor contact.
Provide protection by means of circuit breaker FI 30.
Please observe the standards IEC 62395-2, EN 60519-10.

Electronic Temperature Controller

The ELTC-14 is an electronic temperature controller with digital display for wall mounting. The temperature is measured by a Pt100 sensor, processed by the microcontroller and displayed. After having evaluated the actual and preset values, the appropriate output relays are switched, depending on the configuration.

Cable glands and terminals are provided for the power connection. The unit is supplied in a weather proof plastic enclosure, with a transparent cover.

Advantages:

- LED display operable down to -25 °C
- Programmable 0 °C up to +390 °C
- For switching 20 A resistive load with hybridrelay
- Signaling contact (configurable to operate either as alarm or release contact, potential-free)
- Suitable for Pt100 with 2 or 3 wires
- For connection of up to 2 heating cables
- Operating voltage:
90 - 260 VAC / 50/60 Hz

Applications:

- Industrial applications
- Mechanical, electrical and plumbing (MEP)



Type **ELTC-14**





Technical Information

Type ELTC-14

Data

■ Operating voltage	90-260 VAC 50/60 Hz
■ Power consumption	Max. 4 mA, < 5 W
■ Switching capacity relay 1	20 A with hybridrelay
■ Switching capacity relay 2	8 A, changover contact (alarm)
■ Operating temperature	-25 up to +55 °C
■ Storage temperature	-30 up to +60 °C
■ Display range	-50 up to +400 °C
■ Adjustable range	0 up to +390 °C, optional configuration
■ Sensor connection	Pt100 2-wire, 3-wire, optional configuration
■ Display	LED, red
■ IP rating	IP 65
■ Dimensions (w x h x d)	130 x 130 x 75 mm polycarbonate enclosure

Sensors and display: It is possible to use two types of sensors, either Pt100/2-wire or Pt100/3-wire. Optional display of °C or °F values. In case of use of a Pt100/2-wire unit the actual temperature value can be corrected. Range +/- 10K or +/-18F, respectively. In case of use of a Pt100/3-wire unit the temperature is automatically corrected. Also suitable for use with ELTF-PTEX 1 and 2 sensor.

Relay configuration: relay 1: regulator, relay 2: alarm / temperature reached

Temperature alarm: If the actual value deviates from the preset limit values, an alarm is given and transmitted via alarm relay K2.

Type	Designation	Art. No.
ELTC-14	Standard: Set with cable glands, reducer and blind cover	0620000

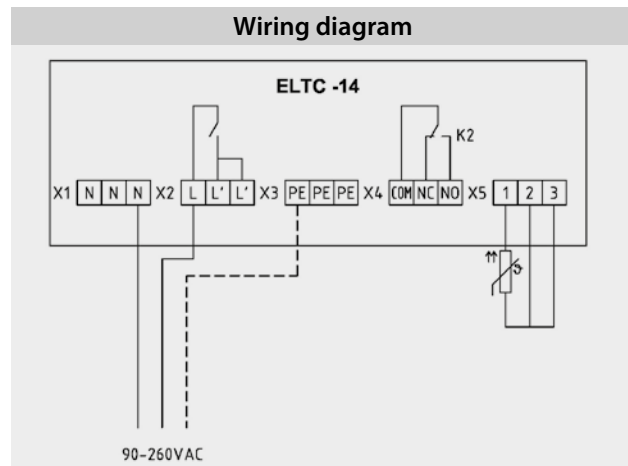

Electronic Temperature Controller

The ELTC-21 is an electronic temperature controller with digital display for top-hat rail mounting. The temperature is measured by a Pt100 sensor, processed by the microcontroller and displayed. After having evaluated the actual and preset values, the appropriate output relays are switched, depending on the configuration.

Advantages:

- LED display operable down to $-25\text{ }^{\circ}\text{C}$
- Programmable $-50\text{ }^{\circ}\text{C}$ up to $+400\text{ }^{\circ}\text{C}$
- For switching 16 A resistive load
- Alarm contact
- Pt100 with 2 or 3 wires

Applications:

- Industrial applications
- Mechanical, electrical and plumbing (MEP)

Technical Information

Data

■ Operating voltage	230 V
■ Power consumption	Max. 4 mA, < 5 W
■ Switching capacity, relay 1	16 A close contact (heating)
■ Switching capacity, relay 2	8 A, changeover contact (alarm)
■ Operating temperature	-25 up to $+55\text{ }^{\circ}\text{C}$
■ Storage temperature	-25 up to $+60\text{ }^{\circ}\text{C}$
■ Temperature range	0 up to $+400\text{ }^{\circ}\text{C}$, opt. configuration
■ Sensor connection	Pt100 2-wires, 3-wires, opt. configuration
■ Display	LED, red
■ IP rating	IP 20
■ Mounting	Top-hat rail
■ Dimensions [w x h x d in mm]:	51.5 x 87.5 x 58.0

Type ELTC-21

Wiring diagram

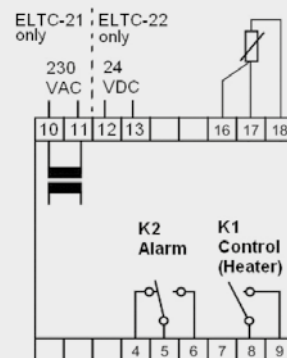

Sensors and display: It is possible to use two types of sensors, either Pt100/2-wire or Pt100/3-wire. Optional display of $^{\circ}\text{C}$ or $^{\circ}\text{F}$ values. In case of use of a Pt100/2-wire unit the actual temperature value can be corrected. Range $\pm 10\text{K}$ or $\pm 18\text{F}$, respectively. In case of use of a Pt100/3-wire unit the temperature is automatically corrected. Also suitable for use with ELTF-PTE_x 1 and 2 sensor.

Relay configuration: relay 1: regulator, relay 2: alarm

Temperature alarm: If the actual value deviates from the preset limit values, an alarm is given and transmitted via alarm relay K2.

Type ELTC-21



ELC

Type	Art. No.
ELTC-21	0610093

Electronic

Temperature Controller for 24 VDC

The ELTC-22 is an electronic temperature controller with digital display for standard rail mounting. The temperature is measured by a Pt100 sensor, processed by the microcontroller and displayed. After having evaluated the actual and preset values, the appropriate output relays are switched, depending on the configuration.

Advantages:

- LED display operable down to -25 °C
- Programmable -50 °C up to +400 °C
- For switching 16 A ohm load
- Alarm contact
- Pt100 with 2 or 3 wires

Applications:

- Industrial applications
- Mechanical, electrical and plumbing (MEP)

Technical Information

Data

■ Operating voltage	24 VDC
■ Power consumption	Max. 4 mA, < 5 W
■ Switching capacity, relay 1	16 A close contact (heating)
■ Switching capacity, relay 2	8 A, changeover contact (alarm)
■ Operating temperature	-25 up to +55 °C
■ Storage temperature	-25 up to +60 °C
■ Temperature range	0 up to +400 °C, opt. configuration
■ Sensor connection	Pt100 2-wires, 3-wires, opt. configuration
■ Display	LED, red
■ IP rating	IP 20
■ Mounting	Top-hat rail
■ Dimensions [w x h x d in mm]:	51.5 x 87.5 x 58.0

Type ELTC-22

Wiring diagram

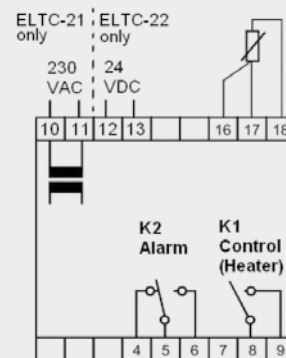

Sensors and display: It is possible to use two types of sensors, either Pt100/2-wire or Pt100/3-wire. Optional display of °C or °F values. In case of use of a Pt100/2-wire unit the actual temperature value can be corrected. Range +/- 10K or +/-18F, respectively. In case of use of a Pt100/3-wire unit the temperature is automatically corrected. Also suitable for use with ELTF-PTEX 1 and 2 sensor.

Relay configuration: relay 1: regulator, relay 2: alarm

Temperature alarm: If the actual value deviates from the preset limit values, an alarm is given and transmitted via alarm relay K2.

Type ELTC-22



ELC

Type	Art. No.
ELTC-22	0610094

Junction Box

Round, for Wall-mounting

This innovative junction box provides a lot of advantages. Due to the shape of the box, for instance, it is not necessary to strongly bend the inserted cable thereby avoiding cable damage.

The unique snap fit permits rapid closing of the cover without needing a special tool. A safety lock, with appropriate tool included, prevents the cover from moving. Additional features permit the attachment of sign plates facilitating easy identification of heating circuits in complex systems.

Advantages:

- Rapid closing of the cover through snap fit, no tool required
- Increased mechanical safety through round shape
- Permits fixing of customer identification plates
- Up to 3 heating cables can be connected

Applications:

- Chemical & petrochemical industries
- Power stations
- Industrial plants with a need for frost protection or temperature maintenance



Type **ELAK-R**





Technical Information

Data

■ Ambient temperature	-45°C up to +50°C
■ Nominal current	See type plate, max. 28 A each terminal 6 mm ²
■ Nominal voltage	See type plate, max. 800 VAC
■ Terminals heating cable	Max. 6 mm ² / AWG 10
■ Terminals temperature sensor	Max 1.5 mm ² / AWG 16
■ Enclosure	Polyamide, RAL 7043 traffic grey
■ Dimensions (approx.):	Dia. 150 mm, height 125 mm
■ Cable glands	Polyamide
■ IP rating	IP65
■ Weight	Approx. 0.7 kg

Type ELAK-R

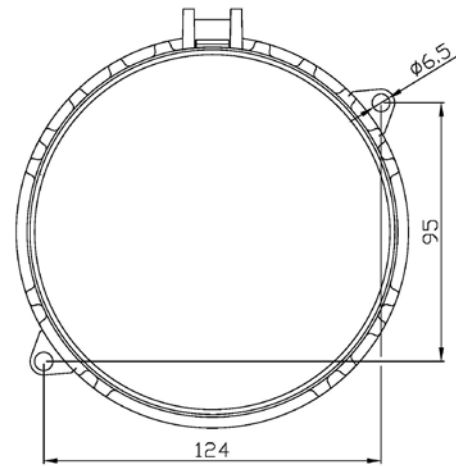

Type	Application	Features	Item n°
ELAK-R-1	Star point for 3 heating cables ELKM-AG (L and N)	wall-mounting, 3 x M16 (3-7)	0920051
ELAK-R-2	Connection of 1 heating cable ELK-AG (L and N) or star point for 3 heating cables ELKM-AG -...	wall-mounting, 1x M25 (9-17), 2 x M16 (3-7), 1 bore hole with thread plug M16 *	0920052
ELAK-R-3	Connection of 1 heating cable ELW-VA	wall-mounting, 1x M25 (9-17), 1 x M20 (6-12)	0920053

Note: Connection and termination kits are not included in the ELAK-R system. Please place a separate order for these items which depend on the type of heating cable used.

Junction Box, Round for Hazardous Areas



The innovative junction box ELAK-Ex-R is suitable for use in potentially explosive atmosphere in accordance with Ex-guidelines 94/9/CE (ATEX 95). Thanks to its exceptional shape it provides a number of advantages. Due to the form of the box, for instance, it is not necessary to strongly bend the inserted cable thereby avoiding cable damage.

A safety lock, with appropriate tool included, prevents the cover from moving. Additional features permitting the attachment of sign plates facilitate easy identification of heating circuits in complex systems. Suited for wall-mounting.

Advantages:

- No static charge
- Rapid closing of the cover through snap fit, no tool required
- Increased mechanical safety through round shape
- Permits fixing of customer identification plates
- Up to 3 heating cables can be connected

Applications:

- Hazardous areas
- Chemical & petrochemical industries
- Power stations
- Industrial plants with a need for frost protection or temperature maintenance



Type **ELAK-Ex-R**





Technical Information

Type ELAK-Ex-R

Data

■ Classification	II 2G Ex e IIC T6 Gb II 2D Ex tb IIIC TX Db
■ Standards	IEC 60079-0 ed.6, IEC 60079-7 ed.4, IEC 60079-31 ed.1
■ Ambient temperature	-40 °C up to +50 °C
■ Nominal current	See type plate, max. 28 A each terminal
■ Nominal voltage	See type plate, max. 550V
■ Terminals heating cable	Max. 6 mm ² (optional 10 mm ²)
■ Terminals temp.sensor (if required)	Max. 1.5 mm ²
■ Enclosure	Polyamide, no static charge
■ Dimensions (approx.)	Ø 150 mm, height 125 mm
■ Impact resistance	7 Joule
■ Cable glands	Polyamide
■ IP rating	IP65
■ Weight	Approx. 0.7 kg
■ Type of mounting	Wall-mounting

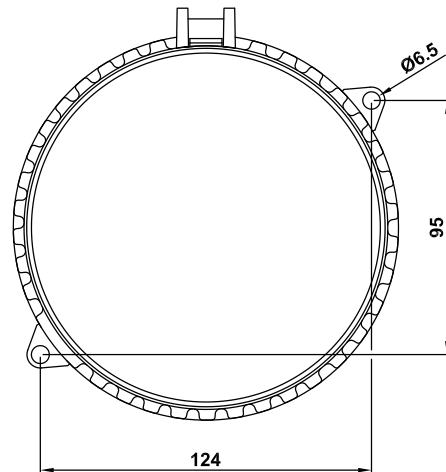

Type	Application	Features	Art. No.
ELAK-Ex-R1	Star point for ELK-AG-...	3 x M16 (4-9 mm), 1 x threaded plug M20, 1 x threaded plug M25	0X80071
ELAK-Ex-R2	Two-phase heating circuit or as star-supply box for ELK-AG-...	2 x M16 (4-9 mm), 1 x M25 (8-17 mm), 1 x threaded plug M16, 1 x threaded plug M20	0X80072
ELAK-Ex-R4	Supply: 1 heating cable ELK-AG-... + EL-CT	2 x M16 (4-9 mm), 2 x M25 (8-17 mm)	0X80074

Note: Connection and termination kits are not included in the ELAK-Ex-R-system. Please place a separate order for these items which depend on the type of heating cable used.

Junction Box

for Hazardous Areas



This junction box ELAK-Ex-3 in conventional design is suitable for use in potentially explosive atmosphere in accordance with Ex-guidelines 94/9/CE (ATEX 95). Moreover, the unit ELAK-Ex-3 covers a significantly wide range of ambient temperatures as shown on the data sheet. The junction box can be wall-mounted and is also available with stands for mounting on pipes.

Advantages:

- Covers a wide range of temperatures
- Suited for mounting on pipes

Applications:

- Hazardous areas
- Chemical & petrochemical industries
- Power stations
- Industrial plants with a need for frost protection or temperature maintenance



Type **ELAK-Ex-3**





Technical Information

Type ELAK-Ex-3

Data

■ Classification	II 2G Ex e IIC T6...T4 Gb II 2D Ex tb IIIC T80 °C Db
■ Certificate	EPS13 ATEX 1506X, IECEX EPS 13.0002
■ Standards	EN 60079-0:2009, EN 60079-7:2007, EN 60079-31:2009
■ Ambient temperature	-40 °C up to +50 °C (T6, T85 °C) -40 °C up to +55 °C (T5, T100 °C) -40 °C up to +60 °C (T4, T100 °C)
■ Nominal current	See type plate, max. 36 A
■ Nominal voltage	See type plate, max. 550V
■ Terminals	Min. 0.5 mm ² , max. 10 mm ² (except ELAK-Ex-3.8)
■ Enclosure	Polyester
■ Dimensions (approx.)	l x h x d 122 x 120 x 90 mm
■ Impact resistance	7 Joule
■ Cable glands	Polyamide
■ IP rating	IP65 / 66 depending on design
■ Weight	Approx. 1 kg
■ Type of mounting	Wall-mounting

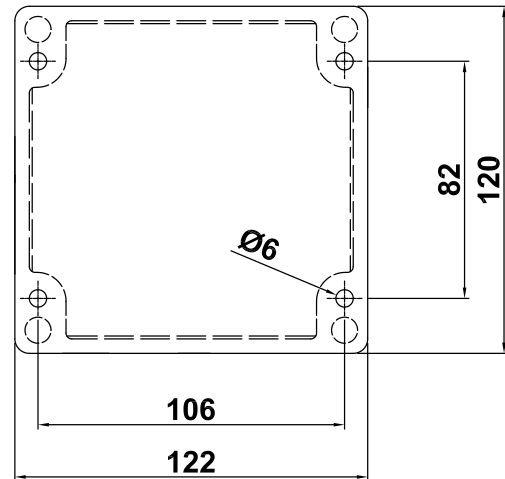





The ELAK-Ex-3 unit fitted with the mounting stand ELMW-9 (122 x 120 – Art. No. 0941009) is also suited for mounting on pipes. The mounting stand is 100 mm high.

Type	Application	Features	Art. No.
ELAK-Ex-3.1	Star point for ELK-AG-...	3 x M12 (3-6 mm), 35 A, 1 x threaded plug M25	0X80051
ELAK-Ex-3.2	Two-phase heating circuit or as star-supply box for ELK-AG-...	1 x M25 (7-17 mm), 2 x M12 (3-6 mm), 1 x sealing plug M12	0X80052
ELAK-Ex-3.4	Supply: 1 heating cable ELK-AG-...+ EL-CTB	2 x M25 (7-17 mm), 2 x M12 (3-6 mm)	0X80054

Note: Connection and termination kits are not included in the ELAK-Ex-3-system. Please place a separate order for these items which depend on the type of heating cable used. Appertaining screws are specified in chapter 'Accessories'.

Heating Cables / Heating Tapes

Accessories

Designation	Description	Art. No.
1	 Connection and Termination Kits	
ELVB-ELPA1-25	Connection kit for ELP/PFA, with cable gland M25x1,5 IP66	091A050
ELVB-ELPA2-25	Connection kit for ELP/Si, with cable gland M25x1,5 IP66	091A052
EL-ECP1	Termination kit for ELP/PFA, silicone end cap (6 mm, transparent) with glue	09112P1
EL-ECP2	Termination kit for ELP/Si, silicone end cap (9 mm, transparent) with glue	09112P3
EL-ECP+	Termination kit for ELP/PFA up to 260 °C, silicone end cap (6 mm, red) with glue	09112PP
 EL-ECP-Ex	Termination kit for ELP/PFA, for Ex area, up to 210 °C, silicone end cap (red) with glue	0X81EP1
 ELVB-ELPEx-25	Connection kit for ELP/PFA, for Ex area, with cable gland M25	0X81PA2
 Ex-Con-25/7	Coupling sleeve for Ex area ELKM-AG-N, conductor section up to 2.5 mm ² , 7J, Ex e	0X81115
 Ex-Con-22/4	Coupling sleeve for Ex area ELKM-AG-N, conductor section up to 2.5 mm ² , 4J, Ex e	0X81135
 Ex-Con-36/4	Coupling sleeve for Ex area ELKM-AG-N, conductor section between 2.5 and 35 mm ² , 4J, Ex e	0X81120
ELVB22	Connection kit for heating cable ELKM-A for 1.5 mm ² cold lead	0911048
ELVB26	Connection kit for heating cable ELKM-AS+AE for 1.5 mm ² cold lead	0911052
ELVB30	Connection kit for heating cable ELKM-AG-N/L for 1.5 mm ² cold lead	0911056
ELVB30-1	Connection kit for heating cable ELKM-AG-N/L up to 6 mm ² cold lead	0911059
2	 Junction Boxes	
 ELAK-Ex 3.1	Junction box, polyester enclosure, for neutral wire connection ELK-AG-N, Ex e	0X80051
 ELAK-Ex 3.2	Junction box, 122 x 120 x 90 mm, polyester enclosure, for ELK-AG, Ex e	0X80052
 ELAK-Ex 3.4	Junction box, 122 x 120 x 90 mm, polyester enclosure, for AG + EL-CT, Ex e	0X80054
 ELAK-Ex 3.8	Junction box, 122 x 120 x 90 mm, polyester enclosure, for Pt100, Ex e	0X80058
 ELAK-Ex-R1	Junction box, dia. 150 mm, height 125 mm, polyamide enclosure, for neutral wire connection, Ex e	0X80071
 ELAK-Ex-R2	Junction box, dia. 150 mm, height 125 mm, polyamide enclosure, for ELK-AG, Ex e	0X80072
 ELAK-Ex-R4	Junction box, dia. 150 mm, height 125 mm, polyamide enclosure, for AG + EL-CT, Ex e	0X80074
 ELAK-Ex-R8	Junction box, dia. 150 mm, height 125 mm, polyamide enclosure, for Pt100, Ex e	0X80078
ELAK-2	Junction box, 98 x 98 x 58 mm, thermoplastic enclosure	0920001
ELAK-5	Junction box, 122 x 120 x 90 mm, polyester enclosure	0920013
ELAK-5.1	Junction box, 130 x 130 x 75 mm, polycarbonate enclosure	0920002
ELAK-7	Junction box, 260 x 190 x 90 mm, polyester enclosure	0920019
ELAK-R-1	Junction box, dia. 150 mm, height 125 mm, thermoplastic enclosure, for neutral wire connection ELK-AG-N/L	0920051
ELAK-R-2	Junction box, dia. 150 mm, height 125 mm, thermoplastic enclosure, for ELK-AG (N or L)	0920052
ELAK-R-3	Junction box, dia. 150 mm, height 125 mm, thermoplastic enclosure, for ELW-VA	0920053
ELAK-R-8	Junction box, dia. 150 mm, height 125 mm, thermoplastic enclosure, for 1 to 2 Pt100, 2-4-wires & up to 2 sensor connecting cables max. 2.5 mm ²	0920058
ELAK-RS-Pt	Junction box, with mounting feet, round, dia. 150 mm, height 125 mm, thermoplastic enclosure, max. temperature 200 °C, to connect 1 double-Pt100, 1 sensor cable, insulating thickness max.100 mm	0920060



Accessories

3



Pipe Mounting Fittings

Designation	Description	Art. No.
ELMW-5	Pipe mounting bracket for ELAK-2, mat. 1.4301/SS 304, max. insulating thickness 80 mm	0941005
ELMW-9	Pipe mounting bracket for ELTh-1, ELAK-Ex-3 and ELAK-5, mat. 1.4301/SS 304, max. insulating thickness 80 mm	0941009
ELMW-11	Pipe mounting bracket for ELAK 5.1, ELTC-14 and 05, mat. 1.4301/SS 304, max. insulating thickness 80 mm	0941011
ELMW-13	Pipe mounting bracket for ELAK-6, ELTh-2, mat. 1.4301/SS 304, max. insulating thickness 80 mm	0941013
ELMW-15	Pipe mounting bracket for ELAK-7, ELTh-3, mat. 1.4301/SS 304, max. insulating thickness 80 mm	0941015
ELMW-Ex-Box	Pipe mounting plate 185 x 185, mat.: 1.4301/SS 304	0941072
ELB-15.04	Hose band clip mat. 1.4301/SS 304, outer hose diameter 25/40 mm, (up to max. DN 25, 1")	2723001025
ELB-15.06	Hose band clip mat. 1.4301/SS 304, outer hose diameter 40/60 mm, (up to max. DN 40, 1.5")	2723001040
ELB-15.09	Hose band clip mat. 1.4301/SS 304, outer hose diameter 70/90 mm, (up to max. DN 65, 2.5")	2723001070
ELB-15.11	Hose band clip mat. 1.4301/SS 304, outer hose diameter 90/110 mm, (up to max. DN 80, 3")	2723001090
ELMW-CT	Pipe mounting bracket, mat. 1.4301/SS 304 used for EL-CT..., max. insulating thickness 80 mm	0941025
ELMW-GP1	Pipe mounting fitting 175 x 125 mm	941020

4



Insulation Bushings



ELISD-1.12	1 x M12, plate dimensions (alu) 70 x 70 mm, insulated area for cable 3,5 ... 7 mm (for connecting cables only)	0921011
ELISD-1.16	1 x M16, plate dimensions (alu) 70 x 70 mm, insulated area for cable 4,5 ... 10 mm (for connecting cables only)	0921015
ELISD-1.20	1 x M20, plate dimensions (alu) 70 x 70 mm, insulated area for cable 7 ... 13 mm (for connecting cables only)	0921019
ELISD-1.25	1 x M25, plate dimensions (alu) 70 x 70 mm, insulated area for cable 9 ... 17mm (for connecting cables only)	0921023
ELISD-P1	Insulation bushing for heating cable ELP/PFA, plate dimensions (alu) 70 x 70 mm, suited for the cold section of constant wattage heating cables	0921101
ELISD-P2	Insulation bushing for heating cable ELP/Si, plate dimensions (alu) 70 x 70 mm, suited for the cold section of constant wattage heating cables	0921031
ELISD-2.12	2 x M12 x 1.5, plate dimensions (alu) 100 x 40 mm, insulated area for cable 3.5...7 mm (for connecting cables only)	0921069
ELISD-2.16	2 x M16 x 1.5, plate dimensions (alu) 100 x 40 mm, insulated area for cable 4.5...10 mm (for connecting cables only)	0921071
ELISD-3.12	3 x M12 x 1.5, plate dimensions (alu) 100 x 40 mm, insulated area for cable 3.5...7 mm (for connecting cables only)	0921067
ELISD-3.16	3 x M16 x 1.5, plate dimensions (alu) 100 x 40 mm, insulated area for cable 4.5...10 mm (for connecting cables only)	0921070

Measuring, controlling and monitoring technology, electronic temperature controllers, electronic heating circuit monitoring device temperature sensors and thermocouples

Please refer to our wide product portfolio, 'Measurement and Control'

Heating Cables / Heating Tapes

Accessories

Designation	Description	Art. No.
5	 Temperature Sensors	
ELTF-PTEx.2	Pt100, Ex e, 4 wires, 3 m PTFE cable, Ex e	0X70002
ELTF-PTEx.4	Double-Pt100, 3 wires, 3 m PTFE cable, Ex e	0X70030
ELTF-PT.1	Pt100 2-wires, 5 m PVC cable	0650001
ELTF-PT.3	Pt100 2-wires, 3 m PTFE cable	0650003
ELTF-PT.3.1	Pt100 3-wires, 3 m PTFE cable	0650002
6	 Self-adhesive Tapes and Foil	
ELB-02	20 m adhesive glass fibre tape, 12 mm, max. working temperature 140 °C	2486800125
ELB-02A	33 m adhesive glass fibre tape, 12 mm, max. working temperature 180 °C	2486800126
ELB-03	50 m textile adhesive tape, 12 mm, max. working temperature 90 °C	2481800120
ELB-06C	50m self-adhesive aluminium foil, 45 mm, reinforced grid, max. working temperature 80°C	2701900051
ELB-06D	100 m self-adhesive aluminium foil, 75 mm, max. working temperature 140 °C	2701900076
ELB-06E	50m self-adhesive aluminium foil, 536 mm, max. working temperature 150 °C	2701900500
ELB-06	50 m self-adhesive aluminium foil, 75 mm wide, max. working temperature 140 °C	942200
7	 Mechanical Fasteners	
ELB-16.10	Plastic strap retainers, length 102 mm, UV resistant , packaged as 100 units, max. working temperature 85 °C	2796000001
ELB-16.20	Plastic strap retainers, length 200 mm, UV resistant, packaged as 100 units, max. working temperature 85 °C	2796000002
ELB-16.36	Plastic strap retainers, length 360 mm, UV resistant, packaged as 100 units, max. working temperature 85 °C	2796000003
ELB-11	Glass-cloth hose 2 mm, max. working temperature 450 °C, for attaching textile glass products	2446000201
ELB-21	Quartz-cloth hose 3,0 mm, max. working temperature 1000 °C, for attaching textile quartz products	2447000350
ELB-13V1	Threaded strap retainer, 11mm, packaged unit = 30 m, mat.: 1.4301/SS 304	2723001010
ELB-13V2	Tension jack for ELB-13V1, packaged unit = 10 pcs., mat.: 1.4301/SS 304	0930042
ELB-12	Pre-punched metal fixing strip, grid:25 mm , mat. 1.4301/SS 304, for attaching heating cables on receptacles	2723001005
ELB-09	Metallic gaze tape 50 mm x 10 m, mat. 1.4301/SS 304	2793000050

Key: ■ suitable, ■ partially suitable



Accessories

8	Designation	Description	Art. No.
		Warning Signs	
	EL-WS01D	German warning sign „Elektrische Begleitheizung“ *	2986900002
	EL-WS01E	English warning sign „Electric Heat Tracing“ *	2986900012
	EL-WS01F	French warning sign „Trçage Electrique“*	2986900032
* also available in other languages upon request			

9			
		Thermal Compound	
	ELWZ 5	Thermal compound, 10 kg bucket, max. working temperature 1.000 °C	2979002952
	ELWZ-5	Thermal compound, 18.3 kg bucket, max. working temperature 1.000 °C	2979002951

10			
		Heat Resistant Cables / Temperature Resistant Cold Ends	
	ELVB-L25	Cold cable 2.5 mm ² for ELKM-AG-N/L*	2045511250
	ELVB-OT	Hose 3G1,5, PTFE/PFA, conductors: green/yellow, brown, blue	2255503016
	ELVB-OS	Hose 3G1,5, silicone, red, conductors: green/yellow, brown, blue	2253330150
	ELVB-L01	Ni conductor 1.5 mm ² , glass fibre insulated, max. working temperature 450 °C, 550 °C transient	2216301500
	ELVB-L02	Ni conductor 2.5 mm ² , glass fibre insulated, max. working temperature 450 °C, 550 °C transient	2216302500
	ELKM-AG-L 0,0072	Applicable as cold end 2.5 mm ² up to 32 A	01TT007E
	ELKM-AG-L 0,0117	Applicable as cold end 1.5 mm ² up to 24 A	01TT011E
	ELKM-AG-N 0,0072	Applicable as cold end 2.5 mm ² up to 32 A	01TA007E
	ELKM-AG-N 0,0117	Applicable as cold end 1.5 mm ² up to 24 A	01TA011E
* other cables and conductors available upon request			

Electrical Heat Tracing System

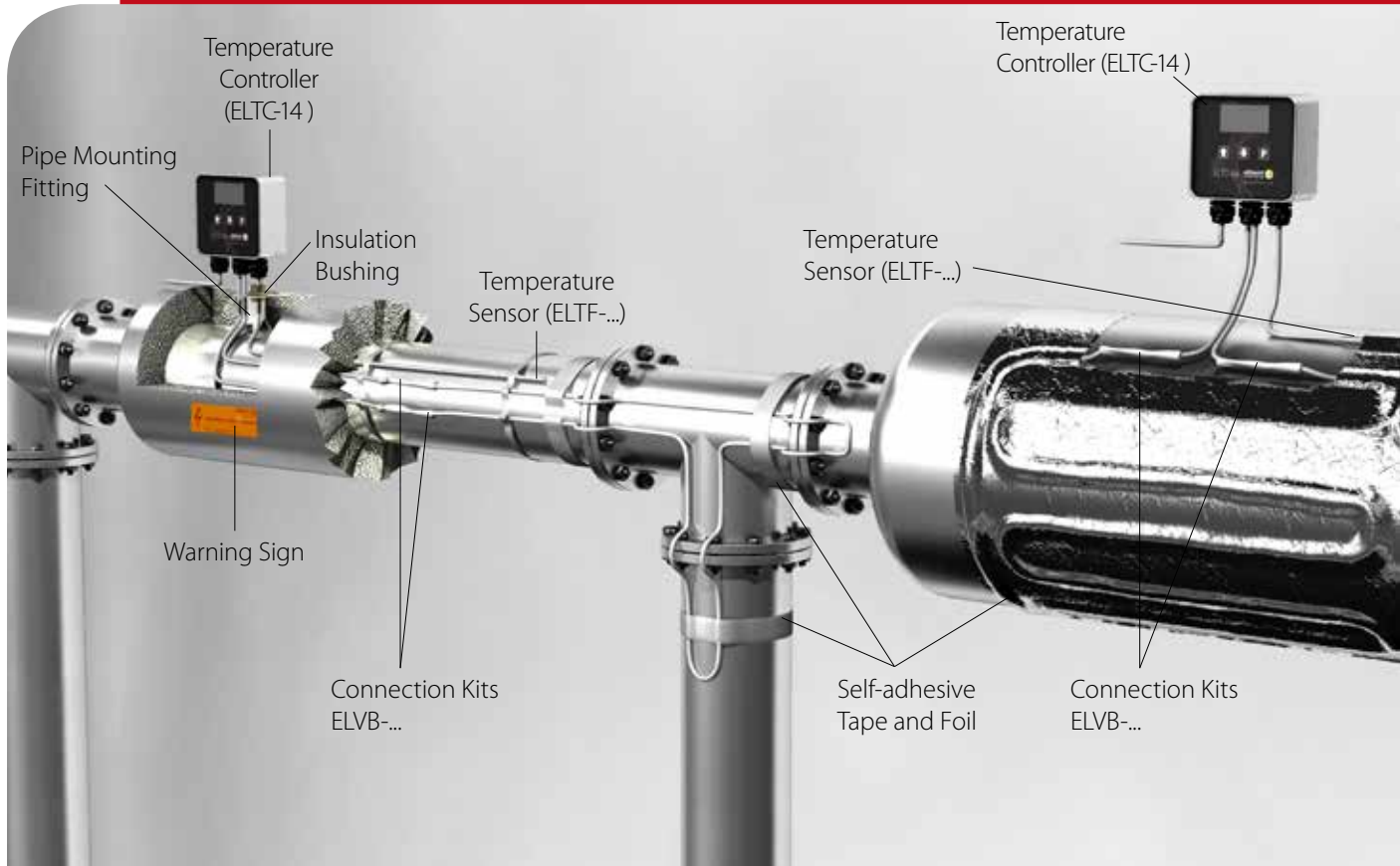

Products:

- Resistance Heating Cable ELK-...
- Measurement and Control, e. g. ELTC-14 Temperature Controller
- Temperature Sensors ELTF-...
- Connection Kits ELVB...
- Insulation Bushings ELISD-...
- Mechanical Fasteners and/or Self-adhesive Tapes and Foil ELB-...
- Pipe Mounting Fittings ELMW-..., ELB-...
- Warning Signs EL-WS...

Remark: This is just a schematic overview, not an installation instruction. For detailed information, please contact our engineers.



EHT in Hazardous Areas

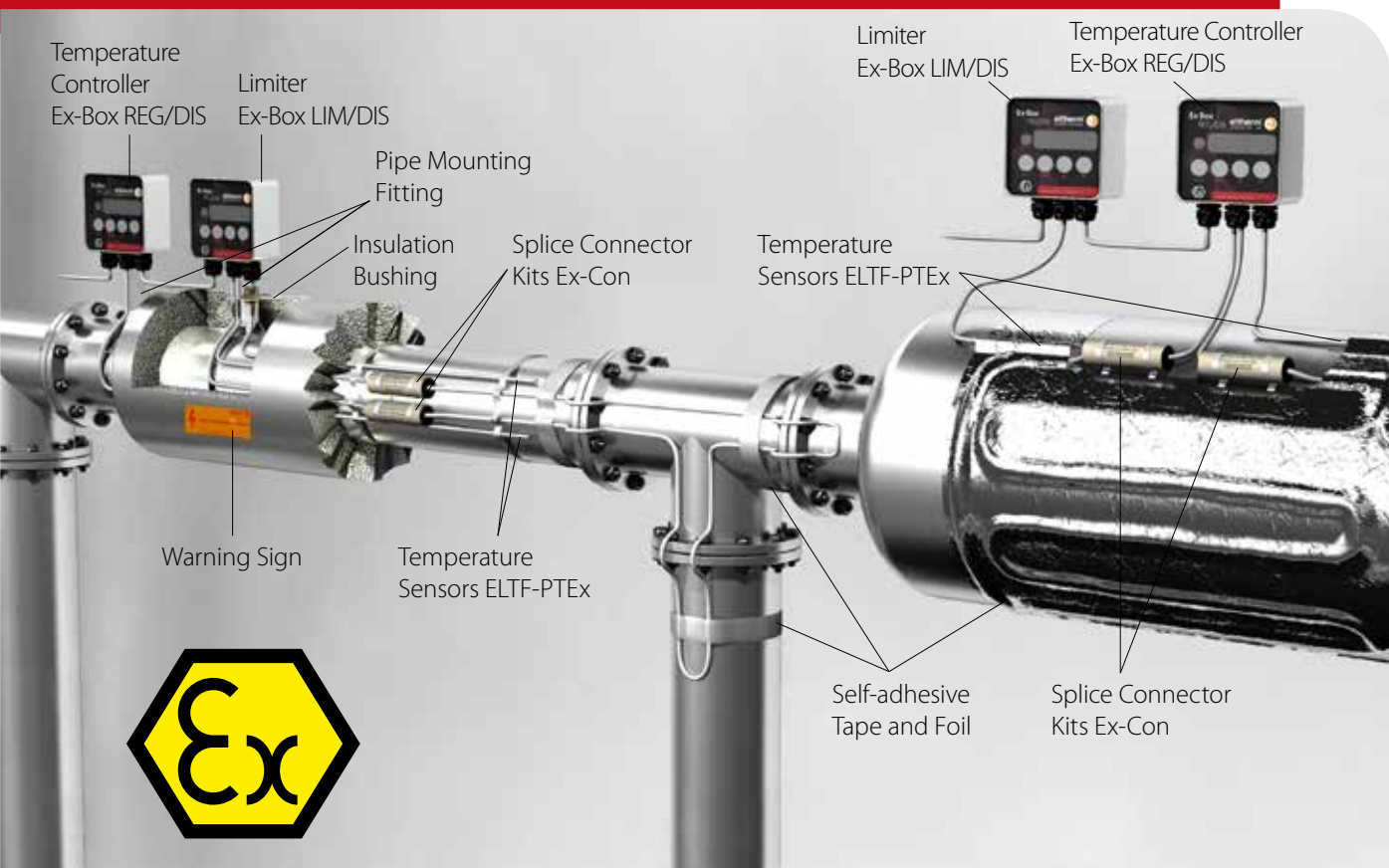

Products:

- Resistance Heating Cable ELK-...
- Temperature Controller e. g. Ex-Box-REG-DIS
- Limiter, e. g. Ex-Box-LIM -DIS
- Temperature Sensor ELTF-PTEX
- Splice Connector Kits Ex-Con-...
- Insulation Bushings ELISD-...
- Mechanical Fasteners and/or Self-adhesive Tapes and Foil ELB-...
- Pipe mounting Fittings ELMW-..., ELB-...
- Warning Signs EL-WS...

Remark: This is just a schematic overview, not an installation instruction. For detailed information, please contact our engineers.

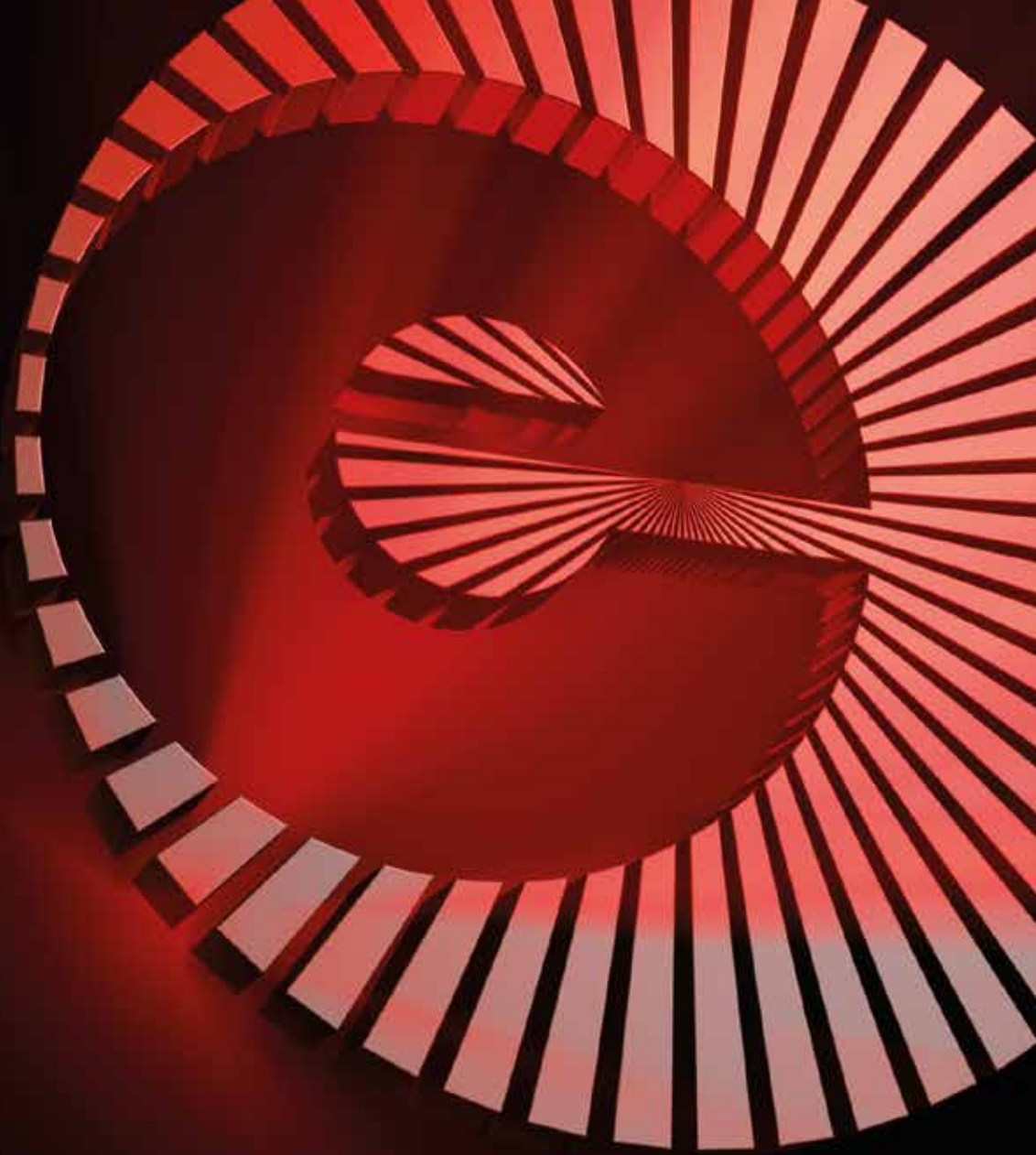

eltherm[®]
innovations in heat tracing



eltherm GmbH
Headquarters / Production site

Your reliable partner worldwide:



**THORNE &
DERRICK**
INTERNATIONAL

Thorne & Derrick
+44 (0) 191 410 4292
www.heatingandprocess.com

innovations in heat tracing