

E-M-HC2-LDP-V1_06 Document Code	Rotronic AG Bassersdorf, Switzerland Unit
HC2-LDP Manual Document Name	Instruction manual Document Type
	Page 1 of 29

HC2-LDP

Low Dewpoint Probe

Instruction Manual



**THORNE &
DERRICK
INTERNATIONAL**

Thorne & Derrick
+44 (0) 191 490 1547
www.heatingandprocess.com

E-M-HC2-LDP-V1_06	Rotronic AG Bassersdorf, Switzerland
Document Code	Unit
HC2-LDP Manual	Instruction manual
Document Name	Document Type
	Page 2 of 29

Table of Contents

Table of Contents	2
1 Overview	3
1.1 Applicability.....	4
1.2 Background Information on the Principle of Measurement	4
2 Mechanical Dimensions	7
2.1 Probe.....	7
2.2 Measurement Chamber.....	8
3 General	9
3.1 Power Supply	9
3.2 Measured Parameters	9
3.3 UART Interface.....	9
3.4 HW4 Software Compatibility.....	10
3.5 Sensor Filter	10
4 User-Specific Settings and Functions	11
4.1 General AirChip4000 Functions.....	11
4.2 Factory Defaults	14
5 Mechanical Installation	15
5.1 Choice of Measurement Point	15
5.2 Installation of the Probe.....	17
5.3 Pin Configuration of Plug Connector	18
6 Maintenance	19
6.1 Service Cable	19
6.2 Calibration	19
6.3 Probe.....	20
7 Firmware Update	21
8 Technical Data	22
8.1 Technical data, measurement chamber	24
9 Accessories	26
10 Additional Documents	28
11 Document Approval	29

E-M-HC2-LDP-V1_06 Document Code	Rotronic AG Bassersdorf, Switzerland Unit
HC2-LDP Manual Document Name	Instruction manual Document Type
	Page 3 of 29

1 Overview

The ROTRONIC low-dewpoint probe is designed to measure trace moisture in the range of -70 .. 85° C (-94 .. 185 °F)_{T_d}. The dew point probes are based on a capacitive trace moisture sensor, a Pt1000 temperature sensor, and the high-precision AirChip4000 measurement electronics for evaluation and processing of the sensor data. The probe is designed for dewpoint/frostpoint measurements in compressed-air systems. The robust stainless-steel housing and the stainless-steel sinter filter make the probe suitable for industrial applications. The output signals from the low-dewpoint probe are exclusively digital. Suitable devices for making the dewpoint/frostpoint and temperature measurements available as analog signals are the ROTRONIC measurement converters in the HF5, HF8 and PF4 series, as well as the ROTRONIC HP22 and HP23 hand-held meters. Alternatively, the probe can be connected directly to a PC USB port, and read out using MS Windows HW4 software.

The low-dewpoint probe has the following features:

- Very high precision measurement of dewpoint, frostpoint and temperature
- Pressure-resistant to 100 bar
- Absolute repeatability guaranteed
- The latest AirChip4000 measurement technology
- HYGROMER® LDP-1 sensor
- Software-based sensor alarm function
- Adjustment by customer possible
- 1-point temperature calibration / adjustment
- Multi-point dew point calibration / adjustment

The units in the LDP series can be kept up to date with regard to improvements in functionality through simple update of the firmware.

E-M-HC2-LDP-V1_06 Document Code	Rotronic AG Bassersdorf, Switzerland Unit
HC2-LDP Manual Document Name	Instruction manual Document Type
	Page 4 of 29

1.1 Applicability

This manual applies to LDP series probes with firmware version V1.5. The low-order digit of the firmware version stands for minor changes, e.g. correction of errors which do not influence the main functionality of the device.

1.2 Background Information on the Principle of Measurement

The presence of liquid water is undesirable in many industrial gases (e.g. compressed air). It can lead to rust in the piping and functional elements, rupture of lubricant films, electrochemical formation of elements, microbial contamination, and icing, with the associated damage to the system. If the dewpoint of the process gas is known, a suitable drying process can be used to lower its (pressure) dewpoint to a point at which the formation of liquid water (condensation) is avoided. By and large, it can be said that the lower the temperature and humidity of a gas is, the lower its pressure dewpoint will be. Determining this kind of low dewpoint, especially at high gas pressure, makes considerable demands on the pressure resistance, chemical resistance, and resolution of the humidity probe, and on the processor power necessary for the electronics to convert temperature and gas humidity to the associated low-dewpoint temperature.

That is why the latest AirChip4000 technology is used in the ROTRONIC low-dewpoint probe. It is based on an enhancement and power boost to the market-proven, high-precision AirChip3000 technology. Humidity measurement is effected by the new, capacitive HYGROMER® LDP-1 sensor. Together with the Pt1000 temperature sensor, it allows the dewpoint or frostpoint to be determined precisely. The AirChip4000 technology can ascertain any of over 8,000 individual points, and guarantees a high degree of repeatability. The increased performance is vital for dewpoint applications, because the slightest variations in the environmental conditions of the delicate trace moisture climate are very important for the results of measurement.

The firmware of the low-dewpoint probe also has an integrated low-pass filter to effectively reduce signal-noise interference. The result is a low-dewpoint measurement precision of $\pm 2 \text{ K T}_d$ in the range $-50 \dots 20 \text{ }^\circ\text{C T}_d$.

Familiar functions of the AirChip3000 technology, such as calibration, adjustment, and compatibility with ROTRONIC measurement transducers and hand-held meters, are also available in the AirChip4000 technology of the LDP probe.

The dewpoint measurement and its equalization time depend on many factors. ROTRONIC therefore provides a measurement chamber (see figures 2, 4, 8 and 9) with a pre-set airflow of 1 litre per minute at 8 bar pressure. In the measurement chamber, the probe experiences constant airflow, which allows very fast, precise dewpoint measurement. The equalization time of the measurement value may vary widely between applications. It depends on the flow velocity in the measurement chamber, the absolute pressure in the measurement line, the dewpoint of the surroundings, and the surface structure of the measurement line.

E-M-HC2-LDP-V1_06	Rotronic AG Bassersdorf, Switzerland
Document Code	Unit
HC2-LDP Manual	Instruction manual
Document Name	Document Type
	Page 5 of 29

1.2.1 Construction of the probe

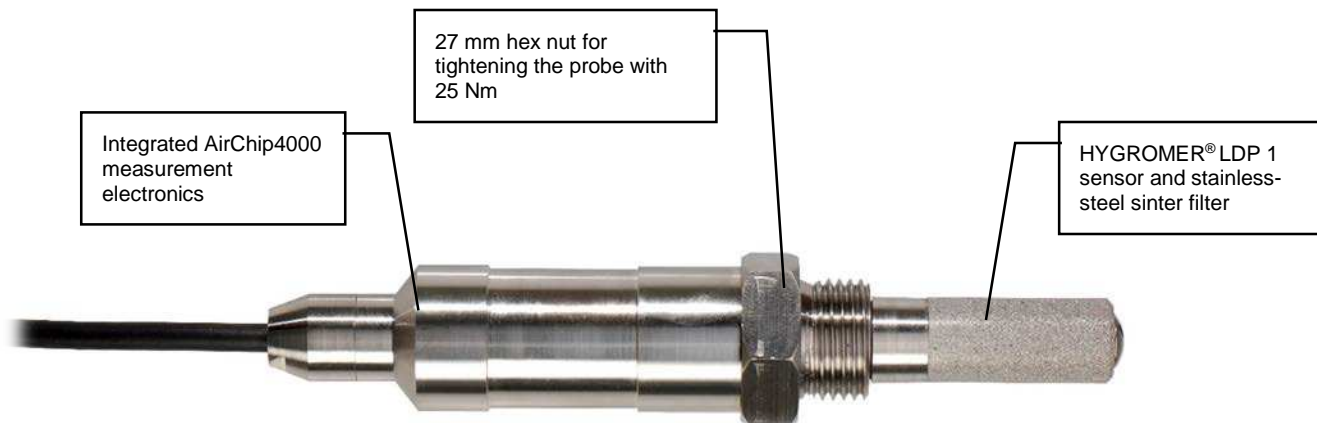

Figure 1: Description of the LDP probe and its components.

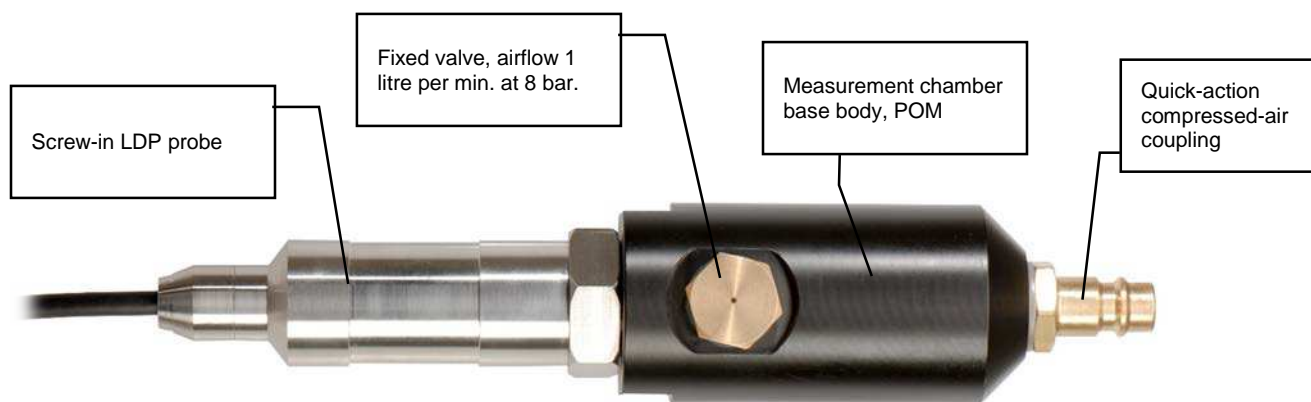

Figure 2: LDP probe, screwed into LDP FC measurement chamber in POM (Polyoxymethylene).

E-M-HC2-LDP-V1_06	Rotronic AG Bassersdorf, Switzerland
Document Code	Unit
HC2-LDP Manual	Instruction manual
Document Name	Document Type
	Page 6 of 29

1.2.2 Measurement chambers

The measurement chamber is available in POM (polyoxymethylene) or stainless steel. It can be ordered as a base body or as a ready-assembled unit with a quick-action compressed-air coupling and fixed valve.

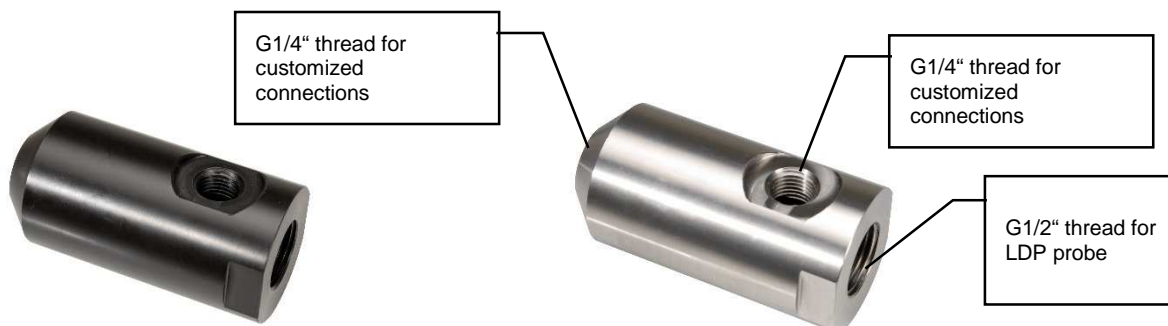

Figure 3: Base body of measurement chamber (LDP MC) in POM (polyoxymethylene) and stainless steel.

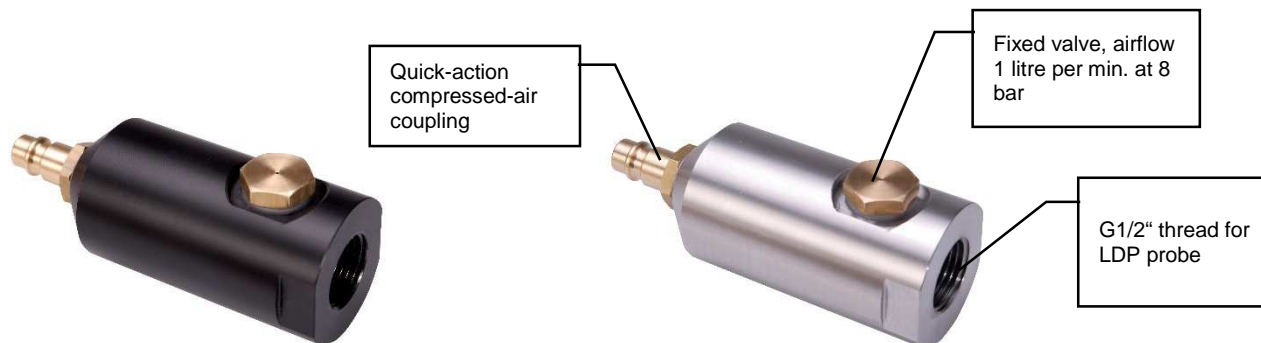

Figure 4: Fully assembled measurement chamber (LDP FC) in POM (polyoxymethylene) and stainless steel.

E-M-HC2-LDP-V1_06	Rotronic AG Bassersdorf, Switzerland
Document Code	Unit
HC2-LDP Manual	Instruction manual
Document Name	Document Type
	Page 7 of 29

2 Mechanical Dimensions

2.1 Probe

The LDP probes are available with 2 metres or 5 metres of cable. Figures 5 and 6 show the sensor head of the low-dewpoint probe.

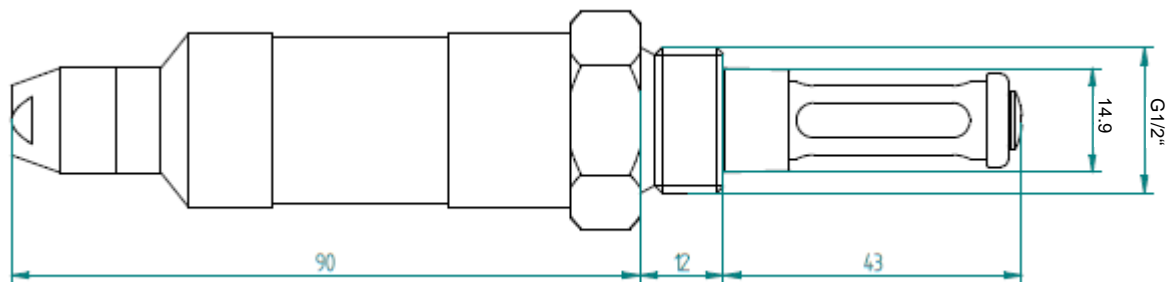

Figure 5: Dimensions of the LDP probe head in mm

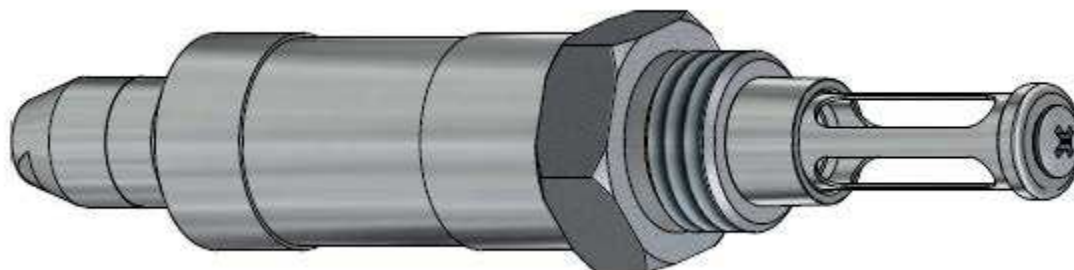

Figure 6: 3D drawing of the probe head.

E-M-HC2-LDP-V1_06	Rotronic AG Bassersdorf, Switzerland
Document Code	Unit
HC2-LDP Manual	Instruction manual
Document Name	Document Type
	Page 8 of 29

2.2 Measurement Chamber

The measurement chamber is available as a complete unit with fixed valve and quick-action compressed-air coupling.

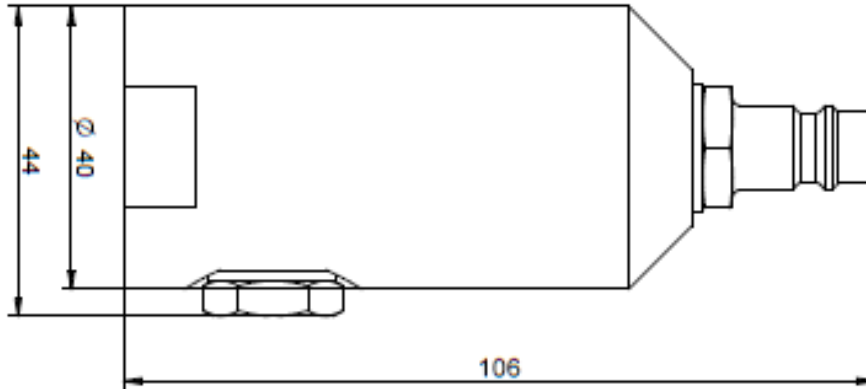

Figure 7: Dimensions (in mm) of the complete measurement chamber with LDP FC fixed valve.

Customized applications can build on the base body.

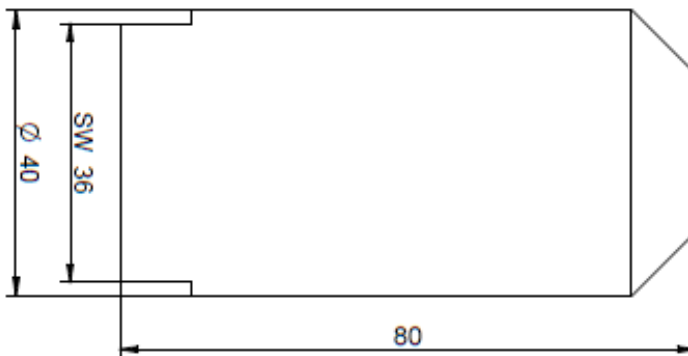

Figure 8: Dimensions (in mm) of the LDP MC measurement chamber base body.

E-M-HC2-LDP-V1_06 Document Code	Rotronic AG Bassersdorf, Switzerland Unit
HC2-LDP Manual Document Name	Instruction manual Document Type
	Page 9 of 29

3 General

3.1 Power Supply

For full functionality, the LDP probe requires a power supply at 3.3 .. 5 VDC (1.5 mA).

3.2 Measured Parameters

The ROTRONIC LDP probe calculates the dewpoint/frostpoint from the humidity measurements taken by the HYGROMER® LDP-1 dewpoint sensor and temperature measurements from a Pt1000 temperature sensor. The values for dewpoint, frostpoint and temperature are transmitted in the form of a digital signal.

3.3 UART Interface

The LDP probe has a serial digital UART interface (UART: Universal Asynchronous Receiver Transmitter), which is compatible to the HF5, HF8, and PF4 measurement transducers, HP22 and HP23 hand-held meters, and the AC3001 service cable (probe UART to PC USB). With the HW4 software (Professional Version) installed on the PC, the following functions are available:

- Recording and display of current measured and calculated values;
- Configuration of the probe;
- Calibration and adjustment of the probe.

Connect the probe to the PC as follows:

- Connect the LDP probe to a USB port of an MS Windows PC via AC3001 (UART-to-USB adapter).
- Use HW4 to search for and include the unit:

Units and groups > Search for units > Search for USB master

E-M-HC2-LDP-V1_06 <small>Document Code</small>	Rotronic AG Bassersdorf, Switzerland <small>Unit</small>
HC2-LDP Manual <small>Document Name</small>	<div style="text-align: right;"> Instruction manual <small>Document Type</small> </div> <hr/> <div style="text-align: right;"> Page 10 of 29 </div>

3.4 HW4 Software Compatibility

LDP series probes are completely integrated in the HW4 software at V3.4.0 or higher.

3.5 Sensor Filter

The probe must always be protected from soiling by a stainless-steel sinter filter. The filter has a pore size of 50 µm (ROTRONIC Order Code: SP-S15/50).

IMPORTANT:

You should not touch the filter with your bare hands. Soiling of any kind can impair the precision and response time of the measurements.

E-M-HC2-LDP-V1_06 Document Code	Rotronic AG Bassersdorf, Switzerland Unit
HC2-LDP Manual Document Name	Instruction manual Document Type Page 11 of 29

4 User-Specific Settings and Functions

The LDP probe has a large number of functions and settings that users can adapt to suit their requirements. This chapter contains an overview of all functions and their default settings.

4.1 General AirChip4000 Functions

This section outlines the general functions of the AirChip family available in the LDP probes. All functions can be used with the HW4 software and are described in detail in the manual **E-M-HW4v3-LDP-001**.

4.1.1 Calibration and adjustment

Dewpoint, frostpoint and temperature adjustment
<ul style="list-style-type: none"> • Multi-point dewpoint/frostpoint calibration and adjustment • Single-point temperature calibration and adjustment • Time stamp for each calibration and adjustment point • Saving and display of the last adjustment data and values • Creation of a calibration and adjustment log

IMPORTANT:

ROTRONIC recommends that you send the probe back to the manufacturer for calibration and adjustment. ROTRONIC has a professional, high-quality calibration system that guarantees optimal, certified results.

4.1.2 Write Protection for Device Settings

Write protection
The device settings can be protected by a password. Password protection is configured with the HW4 software.

E-M-HC2-LDP-V1_06 Document Code	Rotronic AG Bassersdorf, Switzerland Unit
HC2-LDP Manual Document Name	Instruction manual Document Type Page 12 of 29

4.1.3 Alarm Functions

Out-of-limits value alarm
<p>Specific limit values can be defined for dewpoint, frostpoint and temperature; an alarm is shown in the HW4 software when they are exceeded.</p> <p>The alarm function can be enabled or disabled.</p>
Bad sensor alarm
<p>This function is a fixed component of the LDP probe firmware and cannot be disabled. In the case of a short circuit or power interruption at the dewpoint or temperature sensor, a digital alarm is triggered and displayed in the HW4 software. While the alarm is pending, the values for dewpoint/frostpoint are set to the current temperature value (e.g. at 23 °C (73 °F), the display shows 23 °C (73 °F) T_d).</p> <p>In the case of a temperature-sensor alarm, the temperature value is set to -99 °C (-146 °F).</p>

4.1.4 Threshold Monitoring

Automatic threshold monitoring
<p>Threshold monitoring can be enabled or disabled (only with HW4 v3.5).</p> <p>Enabled: (only if wished by customer this function can be enabled by factory)</p> <p>Threshold monitoring becomes active below a measured value of -69.9 °C (-94 °F) T_d. It then sets the measured value to -66 °C (-89 °F) T_d. This allows the user to observe changes in the measured values in the lower limit range.</p> <p>Disabled: (default setting)</p> <p>The value limits integrated in the probe prevent it from measuring values below -70 °C (-94 °F) T_d. The output measurement value is limited at -70 °C (-94 °F) T_d.</p>

There is no static system without any changes. Systems are always in motion and this may must be monitored. In this case the threshold monitoring can be used when changes of the value are important even below -70 °C Td . The following graph shows the drying process of a probe after connecting it to a compressed air system. After reaching -70 °C Td the value jumps back to -66 °C Td and goes further down until the system is stable.



In this case a compressed air system is monitored which is slightly below -70 °C Td . With the threshold monitoring activated, variations (e.g.: opening of valves, extensive use of air, leakage, etc.) in the system can still be seen.

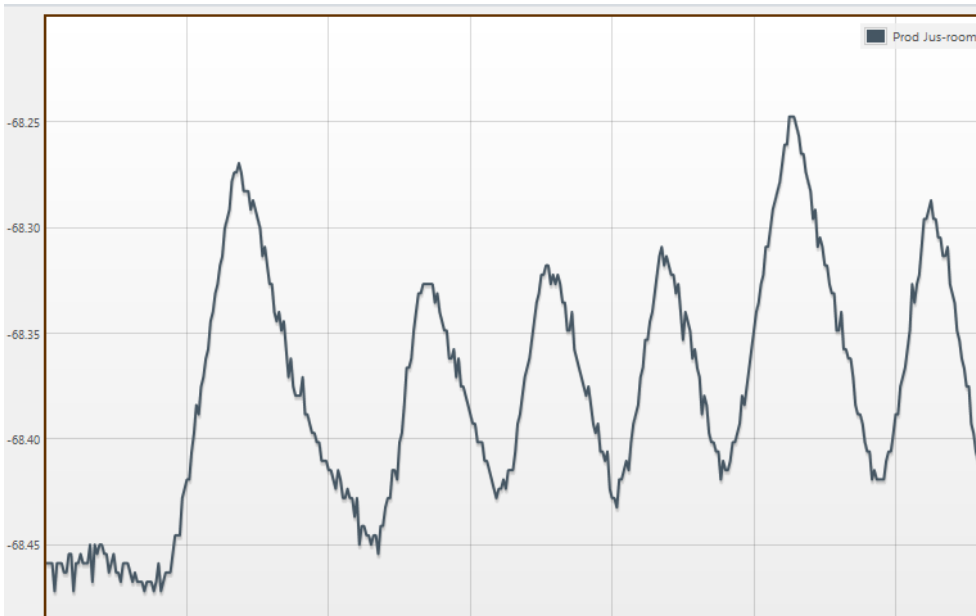

E-M-HC2-LDP-V1_06 Document Code	Rotronic AG Bassersdorf, Switzerland Unit
HC2-LDP Manual Document Name	Instruction manual Document Type Page 14 of 29

4.2 Factory Defaults

All factory defaults and functions of the LDP probe are described below. The HW4 software (V3.4.0 or higher) is needed to change them. An AC3001 service cable can be used to connect the probe to the PC.

Configurable Setting	Factory Default
Unit of measurement (metric/English)	Metric
Automatic threshold-value monitoring	Disabled
Dewpoint/frostpoint	Dewpoint

Functions	Factory Default
Adjustment	Three-point dewpoint adjustment Single-point dewpoint adjustment
Write protection	Disabled
Measured value alarm, invalid measured value (digital alarm)	Disabled
Simulator mode	Disabled

E-M-HC2-LDP-V1_06 Document Code	Rotronic AG Bassersdorf, Switzerland Unit
HC2-LDP Manual Document Name	Instruction manual Document Type
	Page 15 of 29

5 Mechanical Installation

5.1 Choice of Measurement Point

There are several points to note when choosing the point at which to measure the dewpoint/frostpoint.

5.1.1 Positioning the probe and the measurement chamber

The probe can be screwed directly into a line (max. 100 bar), or plugged into a compressed-air connection (max. 16 bar) with a measurement chamber (see figure 9).

IMPORTANT: The measurement chamber must not be connected directly to the compressed air supply without a properly screwed-in probe, and the probe must not be removed from the measurement chamber when the chamber is still under pressure.

It is recommended that you position the probe close to the application to be monitored. Long pipelines from the measurement chamber to the main line that is to be monitored make measurement unnecessarily difficult with regard to amplitude and reaction time. In order to prevent any drop in environmental humidity and pressure from affecting the measurements, there must be no leaks (except for the outlet valve of the measurement chamber).



Figure 9: POM measurement chamber LDP-FCPB1 with compressed-air connection (left), probe insertion thread (right), and fixed valve (top).

5.1.2 Positioning of probe with regard to temperature specifications

Care must be taken that the temperature specifications of the probe are not exceeded by the medium being measured.

If the temperature is too high, the medium must be cooled down. To avoid condensation, the dewpoint must, however, be lower than the ambient temperature.

E-M-HC2-LDP-V1_06 <small>Document Code</small>	Rotronic AG Bassersdorf, Switzerland <small>Unit</small>
HC2-LDP Manual <small>Document Name</small>	<div style="text-align: right;"> Instruction manual <small>Document Type</small> </div> <div style="text-align: right;"> Page 16 of 29 </div>

5.1.3 Filter soiling

Oil and dust particles in the gas line affect the measurement precision, reaction time and lifetime of the probe. The probe's filter cannot filter out particles less than 50 µm in diameter. In this case, it is advisable to install a more effective external filter upstream. The drop in pressure or reduction in flow volume that this causes can impair the measurement precision and reaction time. However, the measurement in its steady state would remain stable over time, even in this setup.

5.1.4 Pressure at the probe head

The maximum permanent pressure for the probe is 100 bar. Please note that the complete measurement chamber with its quick-action coupling and fixed valve is only approved for up to 16 bar.

E-M-HC2-LDP-V1_06	Rotronic AG Bassersdorf, Switzerland
Document Code	Unit
HC2-LDP Manual	Instruction manual
Document Name	Page 17 of 29

5.2 Installation of the Probe

As soon as the measurement point has been determined, the probe can be installed as follows:

1. Push the sealing ring over the filter onto the G1/2" threaded shaft. Use a new sealing ring for every new installation of the probe.
2. Remove the red protective cap. Do not touch the probe filter with your bare hands.
3. First, screw the probe finger-tight into a G1/2" thread.
4. Tighten the probe with a torque wrench set to 25 Nm.

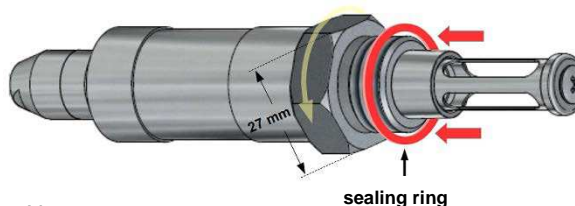

- Important:** The probe must be tightened using only its 27 mm hex section.
5. The probe can be attached only to a transmitter, a hand-held meter or a PC.
 - Connection to a PC: The plug of the probe is connected to a PC via the AC3001 service cable.
 - Connection to a transmitter (HF5, HF8 or PF4): The plug of the probe is attached directly to the probe input on the transmitter.
 - Connection to a hand-held meter (HP22, HP23): The plug of the probe is attached directly to the probe input on the hand-held meter.

E-M-HC2-LDP-V1_06	Rotronic AG Bassersdorf, Switzerland
Document Code	Unit
HC2-LDP Manual	Instruction manual
Document Name	Document Type
	Page 18 of 29

5.3 Pin Configuration of Plug Connector

The low-dewpoint probe has a ROTRONIC E2 plug that is compatible with measurement transducers HF5, HF8, PF4, HP22 and HP23, and with the AC3001 service cable. Its pin configuration is shown in figure 10.

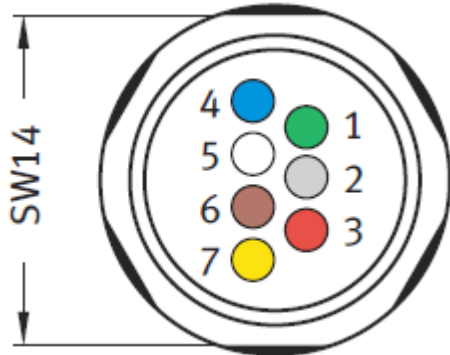

Figure 10: Pin configuration of the E2 plug

Pin	Name	Function
1	V (+)	3.3 .. 5 VDC
2	GND	Supply ground
3	RxD	UART reception line
4	TxD	UART transmission line
5	-	Not connected
6	-	Not connected
7	-	Not connected

E-M-HC2-LDP-V1_06 Document Code	Rotronic AG Bassersdorf, Switzerland Unit
HC2-LDP Manual Document Name	Instruction manual Document Type
	Page 19 of 29

6 Maintenance

This chapter describes calibration, adjustment, validation and filter changes as well as the tools necessary for this, e.g. service cable.

6.1 Service Cable

An **AC3001** service cable can be used for maintenance and calibration. The service cable has an internal power supply of 3.3 VDC. Alternatively, the connection to the PC can be made via an **HF5**, **HF8** or **PF4** transmitter, or an **HP22/HP23** hand-held meter.

6.2 Calibration

Both the **Pt1000-RTD temperature sensor** used in the probe and the corresponding electronics are very stable and **do not normally need to be calibrated** after initial factory calibration. The long-term stability of the **HYGROMER® LDP-1 sensor** from ROTRONIC is normally better than 1. °C T_d per year. For maximum accuracy, the calibration of the probe should be checked every **12 months**. Applications in which the probe is exposed to considerable contamination could require more frequent checks.

IMPORTANT:

ROTRONIC recommends that you send the probe back to the manufacturer for calibration and adjustment. ROTRONIC has a professional, high-quality calibration system that guarantees optimal, certified results.

Customers can carry out the adjustments themselves, using the HW4 software.

- Start the HW4 software and look for the connected LDP probe (*HW4 Menu > Devices and Groups > Search for Devices > Search for USB Master*)
- The device tree of the LDP probe lists all calibration and adjustment functions.
- **At least 2 calibration points** must be recorded, if adjustments are to be made at a later date.
- The adjustment points must be recorded in the sequence from dry to moist; the lowest calibration point must be at the lower limit of the measurement range, with two further points in the range -10 .. 10 °C (14 .. 50 °F) T_d.
- You will find further instructions in the LDP sensor software manual, **E-M-HW4v3-LDP-001**.

E-M-HC2-LDP-V1_06 Document Code	Rotronic AG Bassersdorf, Switzerland Unit
HC2-LDP Manual Document Name	Instruction manual Document Type
	Page 20 of 29

6.2.1 Dewpoint and temperature adjustment

The probe should be calibrated at least once a year, and adjusted if necessary. ROTRONIC strongly advises that you return the probe to the factory for this. If adjustment on site is necessary, the probe should be readjusted at the following dewpoint values.

- -60 °C T_d (±5 °C T_d)
- -10 °C T_d (±5 °C T_d)

You can add further points as necessary. It is advisable to adjust the probe in the order from dry dewpoint value to humid dewpoint value. Ensure that the probe is in steady state at each dewpoint, i.e. the measured dewpoint value no longer changes.

The equipment needed for adjustment (dewpoint reference, low dewpoint generator) has a decisive influence on the measuring accuracy of the probe.

Calibration/adjustment can be performed with the HW4 software. Should it be necessary to adjust the LDP probe, this can be done with the HW4 software. You will find further instructions in the HW4 software manual **E-M-HW4v3-LDP-001** for the LDP probe.

6.3 Probe

It is recommended to carry out maintenance on the probe at least once a year (or, in the case of measurements in oil-polluted air, every 3 months). To do this, remove the filter and submit it to a visual inspection. Soiled parts, such as measurement chamber, fixed valve or filter, must be cleaned in an ultrasonic bath and alcohol, or exchanged. If the sensor is soiled, the probe must be returned to the manufacturer.

IMPORTANT:

The sensor filter must be removed very carefully, because touching the trace moisture sensor can destroy it! The filter should not be touched with bare hands. Any improper maintenance can lead to a reduction in the precision of measurements.

E-M-HC2-LDP-V1_06 Document Code	Rotronic AG Bassersdorf, Switzerland Unit
HC2-LDP Manual Document Name	Instruction manual Document Type
	Page 21 of 29

7 Firmware Update

The LDP probe firmware can be updated with the HW4 software. Firmware updates are available for downloading on the ROTRONIC website. Updating the firmware requires that the probe be connected via an AC3001 service cable to a PC with HW4 software installed on it.

IMPORTANT:

There must be a permanent connection to the computer and a stable power supply during the update process.

Procedure:

- Connect the probe to the service cable, or to an HF5, HF8, PF4, HP22 or HP23.

Remark:

As of 2014, the service cables work with a standard USB driver. Older service cables need a ROTRONIC USB driver, which is installed on the PC together with the HW4 software. For detailed information on the ROTRONIC USB driver, see the manual **E-M-HW4v3-Main**.

- Download the latest LDP probe firmware to your PC from the ROTRONIC website.
- Launch the HW4 software on the PC and search for the LDP probe.

HW4 Main Menu > Devices and Groups > Search for Devices > Search for USB Master / Search for Ethernet Master

- Select the Update option under *Device Manager* in the menu *Extras > Firmware Update*

For further information, see the manual **E-M-HW4v3-LDP-001**.

E-M-HC2-LDP-V1_06 Document Code	Rotronic AG Bassersdorf, Switzerland Unit
HC2-LDP Manual Document Name	Instruction manual Document Type Page 22 of 29

8 Technical Data

General	
Device type	Low-dewpoint/temperature probe
Output signal type	Digital
Compatible	HF5, HF8, PF4, HP22, HP23, AC3001, HW4 (V3.4.0 or higher)

Power supply	
(V+)	3.3...5 VDC
Current consumption	<1.5 mA
Electrical connection	E2 plug (7-pin)
Polarity protection	Mechanical

Dewpoint / frostpoint measurement	
Sensor	HYGROMER® LDP-1
Measurement range	-70...85 °C (-94...185 °F) T _d
Measurement precision at 23 °C (73 °F)	±2 K T _d (-50...20 °C / -58...68 °F T _d) ±3.5 K T _d (-60...-50 °C / -76...-58 °F T _d)
Long-term stability	<1 °C T _d /year
Response time T63: at -50 °C (-58 °F) T _d	Typically: 10 mins. (humid to dry) Typically: 13 s (dry to humid)
Calibration / adjustment	Multi-point calibration / adjustment

Temperature measurement	
Sensor	Pt1000, Class B 1/3 DIN
Measurement range	-40...85 °C / -40...185 °F
Measurement precision at 23 °C (73 °F)	±0.2 K
Response time T63: at -50 °C (-58 °F) T _d	Typically: 15 mins.
Calibration / adjustment	Single-point calibration / adjustment

Startup time and measurement interval	
Startup time	4 s (typical)
Measurement interval	2 s (typical)

E-M-HC2-LDP-V1_06	Rotronic AG Bassersdorf, Switzerland
Document Code	Unit
HC2-LDP Manual	Instruction manual
Document Name	Document Type
	Page 23 of 29

Digital interface	
Interface type	Serial (UART) Baud rate : 19,200 Parity : none Data bits : 8 Stop bits : 1
Maximum length of cable	5 m (16.4 ft)

General specifications	
Material of probe housing	Stainless steel, 1.4301
Filter material	Stainless-steel sinter filter, pore size 50 µm
IP protection	IP65
Pressure resistance, sensor component	16 bar (100 bar with LDP-MCS measurement chamber)
Dimensions	145 x 31 mm (probe head) Hex nut: 27 mm
Weight	260 g (9.2 oz)

Conformity	
CE / EMC immunity	EMC Directive: until 20.04.2016: 2004/108/EG from 20.04.2016: 2014/30/EU EN 61000-6-1: 2007, EN 61000-6-2: 2005 EN 61000-6-3: 2007+A1:2011+AC:2012, EN 61000-6-4: 2007+A1:2011 Performance criterion: www.rotronic.com
Solder type	Lead free (RoHS directive 2011/65/EU)
FDA & GAMP directives	Conforms

Environmental limits	
Storage and transit	-40 .. 85 °C (-40 .. 185 °F) non-condensing
Operation	-40 .. 85 °C (-40 .. 185 °F) non-condensing
Critical environments	Trace moisture sensor: per DV04-14.0803.02 – critical chemicals

E-M-HC2-LDP-V1_06 Document Code	Rotronic AG Bassersdorf, Switzerland Unit
HC2-LDP Manual Document Name	Instruction manual Document Type Page 24 of 29

8.1 Chemical compatibility of LDP-1 sensor

Name	Formula	Concentration	Duration of exposure	Deviation
Carbon dioxide	CO ₂	10,000 ppm	20 min	±0.2 °C T _d
Carbon monoxide	CO	100 ppm	20 min	±0.3 °C T _d
Ammonia	NH ₃	50 ppm	20 min	±0.3 °C T _d
Nitrogen dioxide	NO ₂	5 ppm	20 min	±0.1 °C T _d
Hydrogen	H ₂	3,500 ppm	20 min	±0.2 °C T _d
Hydrogen sulfide	H ₂ S	1 ppm	20 min	±0.6 °C T _d
Ethylene oxide	C ₂ H ₄ O	2...3 %	18 cycle a 90 min	±4 °C T _d
Methane	CH ₄	100 %	11 days	±0.6 °C T _d
Motor oil	-	100 %	Long-time exposure	±0.4 °C T _d
Acetone	CH ₃ COCH ₃	100 %	1 h	±0.4 °C T _d
Toluol	C ₆ H ₅ CH ₃	100 %	3 h	±0.8 °C T _d
Xylene	C ₆ H ₅ (CH ₃) ₂	100 %	3 h	±0.2 °C T _d
Helium	He	10 %	20 h	±0.2 °C T _d
Hydrogen peroxide	H ₂ O ₂	800 ppm	38 days	±1.2 °C T _d

Note:

The deviations were measured at 23°C and 80 %RH (19.37 °C T_d).

E-M-HC2-LDP-V1_06	Rotronic AG Bassersdorf, Switzerland
Document Code	Unit
HC2-LDP Manual	Instruction manual
Document Name	Document Type
	Page 25 of 29

8.2 Technical data, measurement chamber





Base body (LDP-MC)	
Ambient temperature	-40...85 °C (LDP-MCP, POM) -50...100 °C (LDP-MCS, stainless steel)
Pressure resistance	16 bar (LDP-MCP, POM) 100 bar (LDP-MCS, stainless steel)
Dimensions	40 x 106 mm
Connections	G1/2" thread for LDP probe 2 x G1/4" thread
Housing material	POM (LDP-MCP) Stainless steel 1.4301 (LDP-MCS)

Measurement chamber with quick-action coupling and fixed valve (LDP-FC)	
Air flow	1 litre per min. at 8 bar
Measurement range	-40 .. 85 °C (POM version) -50 .. 100 °C (stainless-steel version)
Pressure resistance	16 bar
Dimensions	40 x 106 mm
Connections	G1/2" thread for LDP probe Compressed-air nipple NW7.2
Housing material	Base body: POM / stainless steel 1.4301 Valve: Zirconium oxide Quick-action coupling: Brass

E-M-HC2-LDP-V1_06 Document Code	Rotronic AG Bassersdorf, Switzerland Unit
HC2-LDP Manual Document Name	Instruction manual Document Type Page 26 of 29

9 Accessories

All accessories for ROTRONIC products are to be found in the manual **E-M-HC2-accessories**. The main service cables for the LDP probe are also listed there:

Order Code	Description	
LDP-MCP	Measuring chamber base body, POM	
LDP-MCS	Measuring chamber base body, stainless steel	
LDP-FCPB1	Measurement chamber with fixed coupling and quick-action compressed-air coupling, POM	
LDP-FCSB1	Measurement chamber with fixed valve and quick-action compressed-air coupling, stainless steel	
AC4001-B	Replacement fixed valve	

E-M-HC2-LDP-V1_06

Document Code

Rotronic AG
Bassersdorf, Switzerland

Unit



HC2-LDP Manual

Instruction manual

Document Type

Document Name

Page **27** of 29

AC3001	USB/UART service cable with E2 socket	
SP-S15/50	Stainless-steel sinter filter, 50 µm	
AC4003	Sealing ring	

E-M-HC2-LDP-V1_06 Document Code	Rotronic AG Bassersdorf, Switzerland Unit
HC2-LDP Manual Document Name	Instruction manual Document Type
	Page 28 of 29

10 Additional Documents

Document Name	Contents
E-M-HW4v3-LDP-001	HW4 software manual for operation of the LDP probe.
E-M-HW4v3-Main	HW4 software version 3: general instructions and description of functions.
E-M-HW4v3-DIR	List of all HW4 manuals.
E-M-HC2-accessories	Accessories such as service cables, calibration accessories, filters for probes, transmitters.

Remark:

The document titles are supplemented by the appended version numbers. These version numbers have been omitted in the above table.

E-M-HC2-LDP-V1_06 Document Code	Rotronic AG Bassersdorf, Switzerland Unit
HC2-LDP Manual Document Name	Instruction manual Document Type Page 29 of 29

11 Document Approval

Version	Date	Remark
V1_00	November 2014	Release document
V1_01	November 2014	Graphic of threshold monitoring added
V1_02	March 2015	Response time dry to humid added
V1_03	March 2015	Threshold monitoring is disabled by factory
V1_04	September 2015	Calibration / adjustment specification included
V1_05	November 2015	Chemical compatibility of LDP-1 sensor added
V1_06	May 2016	Update CE guideline



Thorne & Derrick
+44 (0) 191 490 1547
www.heatingandprocess.com