



## LFP Inox AND LFP Cubic

FLEXIBLE UP TO THE PROBE TIP



**THORNE &  
DERRICK  
INTERNATIONAL**

Level sensors

Thorne & Derrick  
+44 (0) 191 490 1547  
[www.heatingandprocess.com](http://www.heatingandprocess.com)

**SICK**  
Sensor Intelligence.



## A solution for every application

Whether it is continuous level measurement, point level measurement or a combination of the two, SICK provides a wide range of solutions for process control, storage, and protection. SICK always has the ideal sensor, suited to any installation situation and a wide range of liquids and measurement environments, and always has the same goal in mind – to enable efficient processes. SICK makes the most of the knowledge it has amassed as the supplier of one of the most comprehensive technology portfolios in this sector, enabling the company to integrate its sensors and systems seamlessly into overall systems.

With its LFP Cubic and LFP Inox level sensors, SICK offers solutions for any application, in any setting.

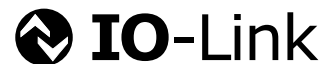

**PWIS-  
cleaned**



# LEVEL MEASUREMENT IN ANY SETTING: LFP Inox AND LFP Cubic

## Reliable and flexible technology

LFP Cubic and LFP Inox are based on time-domain reflectometry (TDR), which enables the sensors to be used universally, no matter what the installation situation, container size or measured medium. This method provides the highest level of reliability and produces the most accurate measurement results.

## The perfect portfolio for any application

With the LFP Cubic and LFP Inox, SICK offers solutions for a wide range of applications: the portfolio features level sensors that are suitable for use in mechanical engineering as well as in the food, beverage and pharmaceutical industries. SICK provides the right solution for every application with different probe lengths and types: this saves space and money.

	LFP Inox 	LFP Cubic 
Hygiene applications (sensors can be used in CIP and SIP processes)	✓	
EHEDG certification	✓	
Foam applications	✓	✓
Rod probe up to 2 m long	✓	✓
Rod probe up to 4 m long	✓	
Cable probe up to 4 m long		✓
Separate electronics housing	✓	✓
Analog output and two switching outputs	✓	✓
Analog output and four switching outputs	✓	✓
WHG (German Water Management Act) certification	✓	
IO-Link communication	✓	✓
Compact variant (without probe)		✓
Wetted parts made from titanium (without probe)		✓

# LFP Inox: THE CLEAN SOLUTION

The materials used in the LFP Inox meet FDA requirements and the whole sensor is EHEDG certified, meaning that the sensor fulfills the most stringent of hygiene requirements. The sensor's temperature and pressure resistance mean it can be used in CIP and SIP processes without any restrictions.

The LFP Inox is a reliable solution from SICK with an outstanding price-performance ratio.



## Hygienic design

- Replaceable hygienic process connections
- CIP and SIP resistant
- Rod probe with a surface roughness smaller than 0.8  $\mu\text{m}$



## Remote amplifier

- Autoclavable – probe can be sterilized easily
- Probe suitable for use at high process temperatures
- Space-saving solution when installation space is tight
- Electronics protected from process heat



## Rugged design

- Easy to clean the sensor thoroughly
- Enclosure ratings IP 67 and IP 69K allow intensive cleaning of the sensor using pressure washers
- Housing: stainless steel 1.4305 and 1.4404



## LFP Inox tolerant of foam and film

- Ignores foam when measuring in liquids such as milk or cleaning agents

# Applications

## Detecting the level in filling machine buffer tanks



### Industry segment:

- Primarily the beverage industry
- Milk production

### Task:

- Continuous monitoring of the fill level

### Special features of the product within the application:

- Foam algorithm
- Quick response time
- Probe up to 4 m long

## Monitoring the level in CIP and SIP systems within the pharmaceutical industry



### Industry segment:

- Primarily in pharmaceuticals and cosmetics industries
- CIP and SIP systems

### Tasks:

- Continuous monitoring of the fill level

### Special features of the product within the application:

- Polished probe surface
- High-grade stainless steel for machine resistance
- Aseptic design

# LFP Cubic: A FLEXIBLE, COST-EFFECTIVE SOLUTION

Almost entirely wear and maintenance-free, the LFP Cubic enables continuous level measurement and point level measurement to be performed with one and the same device. It is ideally suited to use in metal containers and tanks within the water industry, in mechanical engineering, in machine tool, in plant construction and in building technology.



## Design of probe

- Rod probe, 2 m or 4 m long, which can be replaced and shortened
- Coaxial tube up to 2 m long
- Cable probe up to 4 m long
- Compact variant (without probe)



## Remote amplifier

- Space-saving solution when installation space is tight
- Electronics protected from process heat



## One sensor for measuring the point level and continuous level

- High-visibility display
- Two switching outputs (power and voltage signal) and 1 analog output
- Four switching outputs (power and voltage signal) and 1 analog output



## LFP Cubic tolerant of foam and film

- Provides accurate measurements, even in liquids that foam and form a film

# Applications

## Monitoring the fill level of water and chemicals in cleaning systems

### Industry segment:

- Mechanical engineering
- Electroplating industry
- Steel production

### Tasks:

- Continuous measuring
- Monitoring the point level of liquids

### Special features of the product within the application:

- Four limit points detection
- Foam algorithm
- High-grade stainless steel



## Monitoring lubricants and hydraulic oils in CNC machines

### Industry segment:

- Machine tool engineering
- Automotive and parts supplier industries
- Hydraulics industry

### Tasks:

- Monitoring via the sensor display
- Monitoring the point level

### Special features of the product within the application:

- Fast commissioning
- Coaxial tube for oil applications
- Clear indication of measured values on the display



# THE CLEAN SOLUTION





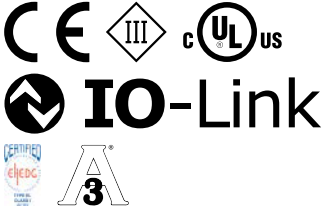

### Additional information

Detailed technical data . . . . .	9
Ordering information . . . . .	10
Type code . . . . .	15
Dimensional drawings . . . . .	16
Connection type . . . . .	18
Accessories . . . . .	18

## Product description

The LFP Inox is a hygienic level sensor for liquids using TDR technology – a process for determining the time of flight of electromagnetic waves. The time difference between the sent pulse and the reflected pulse is used to generate a level signal, both as a continuous value (analog output) and a freely positionable switching point (switching output). The use of FDA-compliant materials in an EHEDG-certified design means that the LFP Inox can be relied upon for optimum

and unrestricted cleaning, even in applications with the most stringent hygiene requirements. Its modular connection system allows simple and flexible installation in any application. Thanks to high temperature and pressure resistance, unrestricted use is possible under CIP and SIP conditions. This impressive profile is topped off with communication capability via IO-Link to the superordinate control units.

## At a glance

- Level measurement in hygienic applications
- Manually retractable monoprobe up to 4,000 mm long with Ra ≤ 0.8 µm
- Process temperature up to 180 °C, process pressure up to 16 bar
- CIP/SIP-resistant
- High enclosure rating: IP67 and IP69K, autoclavable
- Interchangeable hygienic process connections
- 3-in-1: combined display, analog output, and binary output
- Remote amplifier with process connection

## Your benefits

- Robust design increases service life
- High flexibility due to cuttable probe and interchangeable connection concept
- Cost savings due to multiple output signals: one system for both level detection and continuous level monitoring
- Time and cost savings due to low maintenance without any calibration and quick commissioning Remote display of the measured value and space savings

→ [www.sick.com/LFP\\_Inox](http://www.sick.com/LFP_Inox)

For more information, simply enter the link or scan the QR code and get direct access to technical data, CAD design models, operating instructions, software, application examples, and much more.





## Detailed technical data

## Features

Medium	Fluids
Measurement	Switch, continuous
Design	Standard Remote amplifier, length of cable 1 m Remote amplifier, length of cable 2 m Remote amplifier, length of cable 3.3 m (depending on type)
Probe length	200 mm ... 4,000 mm
Process pressure	-1 bar ... +16 bar
Process temperature	-20 °C ... +180 °C (depending on type)
GOST approval	✓
UL approval	✓
RoHS certificate	✓
IO-Link	✓
EHEDG approval	✓
3-A	- / ✓ (depending on type)
PWIS-cleaned	- / ✓ (depending on type)

## Performance

Accuracy of sensor element	$\pm 5 \text{ mm}^{1)}$
Repeatability	$\leq 2 \text{ mm}$
Resolution	$< 2 \text{ mm}$
Response time	$< 400 \text{ ms}^{2)}$
Dielectricity constant	$\geq 5$ for mono probe $\geq 1.8$ with coaxial probe
Conductivity	No limitation
Deactivated area at end of probe	$10 \text{ mm}^{3)}$
MTTF	194.3 years (EN ISO 13849-1)

<sup>1)</sup> For details see accuracy diagram in the operating instructions LFP Inox.

<sup>2)</sup> Dependent on measuring mode (high speed  $< 400 \text{ ms}$ , high accuracy  $< 2,800 \text{ ms}$ ).

<sup>3)</sup> With water under reference conditions.

## Mechanics

Wetted parts	316L (Ra $\leq 0,8 \mu\text{m}$ ), PEEK
Process connection	G $\frac{3}{4}$ A / $\frac{3}{4}$ " NPT, G $\frac{3}{4}$ (hygienic process connectors with adapter for G $\frac{3}{4}$ , see accessories)
Housing material	303
Housing design	With viewing panel made from PMMA (acrylic glass) / with closed cover (depending on type)
Max. probe load	$\leq 6 \text{ Nm}$
Material coaxial cable	FEP
Length coaxial cable	1 m ... 3.3 m (depending on type)
Electrical cable insulation	PVC (depending on type)

## Electronics

Supply voltage	12 V DC ... 30 V DC <sup>1)</sup>
Power consumption	$\leq 75 \text{ mA}$ at 24 V DC without output load
Initialization time	$\leq 2 \text{ s}$

<sup>1)</sup> All connections are polarity protected. All outputs are overload and short-circuit protected.

Protection class	III
Electrical connection	Round connector M12 x 1, 5-pin Round connector M12 x 1, 8-pin Cable connector M12 x 1, 5-polig Cable connector M12 x 1, 8-polig (depending on type)
Output signal	4 mA ... 20 mA, 0 V ... 10 V automatic switching depending on the load, 1 PNP transistor output (Q1) and 1 PNP/NPN transistor output (Q2) switchable, or 1 PNP transistor output (Q1) and 3 PNP/NPN transistor outputs (Q2 ... Q4) switchable (depending on type) <sup>1)</sup>
Output load	4 mA ... 20 mA < 500 Ohm at U <sub>v</sub> > 13,5 V 4 mA ... 20 mA < 400 Ohm at U <sub>v</sub> > 12 V 0 V ... 10 V > 750 Ohm at U <sub>v</sub> 14 ≥ V
Hysteresis	Min. 2 mm, free adjustable
Signal voltage HIGH	V <sub>s</sub> - 2 V
Signal voltage LOW	≤ 2 V
Output current	< 100 mA
Inductive load	< 1 H
Capacitive load	100 nF
Enclosure rating	IP 67: EN 60529, IP 69K: EN 40050
Temperature drift	< 0.1 mm/K
Lower signal level	3.8 mA ... 4 mA
Upper signal level	20 mA ... 20.5 mA

<sup>1)</sup> All connections are polarity protected. All outputs are overload and short-circuit protected.

### Ambient data

Ambient operating temperature	-20 °C ... +60 °C
Ambient storage temperature	-40 °C ... +80 °C
Ambient temperature coaxial cable	-20 °C ... +60 °C
Outdoor use	Only with weather protection cover

### Ordering information

#### Standard amplifier

- **Enclosure rating:** IP 67: EN 60529, IP 69K: EN 40050
- **Output signal:** 1 x PNP + 1 x PNP/NPN + 4 mA ... 20 mA / 0 V ... 10 V
- **Process temperature:** -20 °C ... +150 °C
- **Process pressure:** -1 bar ... 16 bar
- **Housing material:** 303
- **Electrical connection:** round connector M12 x 1, 5-pin

Process connection	Housing design	Probe length	Type	Part no.
G ¾ A	With viewing panel made from PMMA (acrylic glass)	200 mm	LFPO200-G1NMB	1060307
		300 mm	LFPO300-G1NMB	1053288
	With closed cover	300 mm	LFPO300-G2NMB	1056287
			LFPO300-G3NMB	1058574
¾" NPT	With viewing panel made from PMMA (acrylic glass)	300 mm	LFPO300-N1NMB	1056927
		G ¾ A	With viewing panel made from PMMA (acrylic glass)	400 mm
400 mm	LFPO400-G2NMB			1056225
With closed cover	500 mm		LFPO500-G1NMB	1052070
			500 mm	LFPO500-G2NMB

Process connection	Housing design	Probe length	Type	Part no.
3/4" NPT	With viewing panel made from PMMA (acrylic glass)	500 mm	LFP0500-N1NMB	1058043
G 3/4 A		600 mm	LFP0600-G1NMB	1052071
	With closed cover	600 mm	LFP0600-G2NMB	1056289
3/4" NPT		600 mm	LFP0600-N1NMB	1059412
	With viewing panel made from PMMA (acrylic glass)	700 mm	LFP0700-G1NMB	1052072
G 3/4 A		700 mm	LFP0700-G2NMB	1056290
3/4" NPT	With viewing panel made from PMMA (acrylic glass)	700 mm	LFP0700-N1NMB	1059413
		800 mm	LFP0800-G1NMB	1052073
G 3/4 A	With closed cover	800 mm	LFP0800-G2NMB	1056291
3/4" NPT		800 mm	LFP0800-N1NMB	1059414
	With viewing panel made from PMMA (acrylic glass)	900 mm	LFP0900-G1NMB	1052074
G 3/4 A		900 mm	LFP0900-G2NMB	1056292
3/4" NPT	With viewing panel made from PMMA (acrylic glass)	900 mm	LFP0900-N1NMB	1059415
		1,000 mm	LFP1000-G1NMB	1052075
	With closed cover	1,000 mm	LFP1000-G1NMBL	1073551
G 3/4 A		1,000 mm	LFP1000-G2NMB	1056204
3/4" NPT	With viewing panel made from PMMA (acrylic glass)	1,000 mm	LFP1000-N1NMB	1055623
		1,100 mm	LFP1100-G1NMB	1052076
G 3/4 A	With closed cover	1,100 mm	LFP1100-G2NMB	1056293
3/4" NPT		1,100 mm	LFP1100-N1NMB	1059416
	With viewing panel made from PMMA (acrylic glass)	1,200 mm	LFP1200-G1NMB	1052077
G 3/4 A		1,200 mm	LFP1200-G21NMB	1056294
3/4" NPT	With viewing panel made from PMMA (acrylic glass)	1,200 mm	LFP1200-N1NMB	1059417
		1,300 mm	LFP1300-G1NMB	1052078
G 3/4 A	With closed cover	1,300 mm	LFP1300-G2NMB	1056295
3/4" NPT		1,300 mm	LFP1300-N1NMB	1059418
	With viewing panel made from PMMA (acrylic glass)	1,400 mm	LFP1400-G1NMB	1052079
G 3/4 A		1,400 mm	LFP1400-G2NMB	1056296
3/4" NPT	With viewing panel made from PMMA (acrylic glass)	1,400 mm	LFP1400-N1NMB	1059419
		1,500 mm	LFP1500-G1NMB	1052080
G 3/4 A	With closed cover	1,500 mm	LFP1500-G2NMB	1056297
3/4" NPT		1,500 mm	LFP1500-N1NMB	1059420
	With viewing panel made from PMMA (acrylic glass)	1,600 mm	LFP1600-G1NMB	1052081
G 3/4 A		1,600 mm	LFP1600-G2NMB	1056298
3/4" NPT	With viewing panel made from PMMA (acrylic glass)	1,600 mm	LFP1600-N1NMB	1059421
		1,700 mm	LFP1700-G1NMB	1052082
G 3/4 A	With closed cover	1,700 mm	LFP1700-G2NMB	1056299
3/4" NPT		1,700 mm	LFP1700-N1NMB	1059422
	With viewing panel made from PMMA (acrylic glass)	1,800 mm	LFP1800-G1NMB	1052083
G 3/4 A		1,800 mm	LFP1800-G2NMB	1056300
3/4" NPT	With viewing panel made from PMMA (acrylic glass)	1,800 mm	LFP1800-N1NMB	1059423
		1,900 mm	LFP1900-G1NMB	1052084
G 3/4 A	With closed cover	1,900 mm	LFP1900-G2NMB	1056301

Process connection	Housing design	Probe length	Type	Part no.
¾" NPT	With viewing panel made from PMMA (acrylic glass)	1,900 mm	LFP1900-N1NMB	1059424
		2,000 mm	LFP2000-G1NMB	1052085
G ¾ A	With closed cover		LFP2000-G1NMBL	1073552
		2,000 mm	LFP2000-G2NMB	1056302
¾" NPT	With viewing panel made from PMMA (acrylic glass)	2,000 mm	LFP2000-N1NMB	1059425
		2,100 mm	LFP2100-G1NMB	1065358
		2,200 mm	LFP2200-G1NMB	1063398
		2,300 mm	LFP2300-G1NMB	1065359
		2,400 mm	LFP2400-G1NMB	1065360
		2,500 mm	LFP2500-G1NMB	1065361
		2,600 mm	LFP2600-G1NMB	1065362
		2,700 mm	LFP2700-G1NMB	1065363
		2,800 mm	LFP2800-G1NMB	1064856
		2,900 mm	LFP2900-G1NMB	1065346
		3,000 mm	LFP3000-G1NMB	1065347
		3,100 mm	LFP3100-G1NMB	1065348
		3,200 mm	LFP3200-G1NMB	1065349
		3,300 mm	LFP3300-G1NMB	1065350
		3,400 mm	LFP3400-G1NMB	1065351
		3,500 mm	LFP3500-G1NMB	1065352
		3,600 mm	LFP3600-G1NMB	1065353
		3,700 mm	LFP3700-G1NMB	1065354
		3,800 mm	LFP3800-G1NMB	1065355
		3,900 mm	LFP3900-G1NMB	1065356
G ¾ A		4,000 mm	LFP4000-G1NMB	1065357

- **Enclosure rating:** IP 67: EN 60529, IP 69K: EN 40050
- **Output signal:** 1 x PNP + 3 x PNP/NPN + 4 mA ... 20 mA / 0 V ... 10 V
- **Process temperature:** -20 °C ... +150 °C
- **Process pressure:** -1 bar ... 16 bar
- **Housing material:** 303
- **Electrical connection:** round connector M12 x 1, 8-pin

Process connection	Housing design	Probe length	Type	Part no.
G ¾ A	With viewing panel made from PMMA (acrylic glass)	500 mm	LFP0500-G6NMC	1080617
	With closed cover	500 mm	LFP0500-G7NMC	1080618
¾" NPT	With viewing panel made from PMMA (acrylic glass)	500 mm	LFP0500-N6NMC	1080639
G ¾ A		1,000 mm	LFP1000-G6NMC	1077065
¾" NPT	With closed cover	1,000 mm	LFP1000-G7NMC	1080623
	With viewing panel made from PMMA (acrylic glass)	1,000 mm	LFP1000-N6NMC	1077066
G ¾ A	With viewing panel made from PMMA (acrylic glass)	2,000 mm	LFP2000-G6NMC	1080628
	With closed cover	2,000 mm	LFP2000-G7NMC	1080629
¾" NPT	With viewing panel made from PMMA (acrylic glass)	2,000 mm	LFP2000-N6NMC	1080634

- **Enclosure rating:** IP 67: EN 60529, IP 69K: EN 40050
- **Output signal:** 1 x PNP + 1 x PNP/NPN + 4 mA ... 20 mA / 0 V ... 10 V
- **Process temperature:** -20 °C ... +150 °C
- **Process pressure:** -1 bar ... 16 bar
- **Housing material:** 303
- **Electrical connection:** Cable connector M12 x 1, 5-polig

Process connection	Housing design	Probe length	Type	Part no.
G ¾ A	With viewing panel made from PMMA (acrylic glass)	500 mm	LFP0500-GANMB	1080619
	With closed cover	500 mm	LFP0500-GBNMB	1080620
¾" NPT	With viewing panel made from PMMA (acrylic glass)	500 mm	LFP0500-NANMB	1080640
G ¾ A		1,000 mm	LFP1000-GANMB	1080624
¾" NPT	With viewing panel made from PMMA (acrylic glass)	1,000 mm	LFP1000-GBNMB	1080625
	With closed cover	1,000 mm	LFP1000-NANMB	1080637
G ¾ A	With viewing panel made from PMMA (acrylic glass)	2,000 mm	LFP2000-GANMB	1080630
	With closed cover	2,000 mm	LFP2000-GBNMB	1080631
¾" NPT	With viewing panel made from PMMA (acrylic glass)	2,000 mm	LFP2000-NANMB	1080635

- **Enclosure rating:** IP 67: EN 60529, IP 69K: EN 40050
- **Output signal:** 1 x PNP + 3 x PNP/NPN + 4 mA ... 20 mA / 0 V ... 10 V
- **Process temperature:** -20 °C ... +150 °C
- **Process pressure:** -1 bar ... 16 bar
- **Housing material:** 303
- **Electrical connection:** Cable connector M12 x 1, 8-polig

Process connection	Housing design	Probe length	Type	Part no.
G ¾ A	With viewing panel made from PMMA (acrylic glass)	500 mm	LFP0500-GCNMC	1080621
	With closed cover	500 mm	LFP0500-GDNMC	1080622
¾" NPT	With viewing panel made from PMMA (acrylic glass)	500 mm	LFP0500-NCNMC	1080641
G ¾ A	With closed cover	1,000 mm	LFP1000-GDNMC	1080627
¾" NPT	With viewing panel made from PMMA (acrylic glass)	1,000 mm	LFP1000-NCNMC	1080638
G ¾ A	With viewing panel made from PMMA (acrylic glass)	2,000 mm	LFP2000-GDNMC	1080633
	With closed cover	2,000 mm	LFP2000-NCNMC	1080636

Remote amplifier

- **Enclosure rating:** IP 67: EN 60529, IP 69K: EN 40050
- **Output signal:** 1 x PNP + 1 x PNP/NPN + 4 mA ... 20 mA / 0 V ... 10 V
- **Process temperature:** -20 °C ... +180 °C
- **Process pressure:** -1 bar ... 16 bar
- **Housing material:** 303
- **Electrical connection:** round connector M12 x 1, 5-pin

Process connection	Housing design	Probe length	Cable length	Type	Part no.			
G 3/4 A	With viewing panel made from PMMA (acrylic glass)	300 mm	3.3 m	LFP0300-G1DMB	1071124			
3/4" NPT		300 mm	3.3 m	LFP0300-N1DMB	1071139			
G 3/4 A		500 mm		1 m	LFP0500-G1BMB	1071118		
				2 m	LFP0500-G1CMB	1071121		
				3.3 m	LFP0500-G1DMB	1071125		
3/4" NPT		500 mm		1 m	LFP0500-N1BMB	1071133		
				2 m	LFP0500-N1CMB	1071136		
				3.3 m	LFP0500-N1DMB	1071140		
G 3/4 A		700 mm		3.3 m	LFP0700-G1DMB	1071126		
3/4" NPT				3.3 m	LFP0700-N1DMB	1071141		
G 3/4 A		1,000 mm		1 m	LFP1000-G1BMB	1071119		
				2 m	LFP1000-G1CMB	1071122		
				3.3 m	LFP1000-G1DMB	1071127		
				With closed cover	1,000 mm	1 m	LFP1000-G2BMB	1071128
						2 m	LFP1000-G2CMB	1071130
						3.3 m	LFP1000-G2DMB	1071132
3/4" NPT	1,000 mm	With viewing panel made from PMMA (acrylic glass)	1 m	LFP1000-N1BMB	1071134			
			2 m	LFP1000-N1CMB	1071137			
			3.3 m	LFP1000-N1DMB	1071142			
	With closed cover	1,000 mm	1 m	LFP1000-N2BMB	1071143			
			3.3 m	LFP1000-N2DMB	1071147			
			2 m	LFP1000-NCBMB	1071145			
G 3/4 A	2,000 mm	With viewing panel made from PMMA (acrylic glass)	1 m	LFP2000-G1BMB	1071120			
			2 m	LFP2000-G1CMB	1071123			
	With closed cover	2,000 mm	1 m	LFP2000-G2BMB	1071129			
			2 m	LFP2000-G2CMB	1071131			
3/4" NPT	2,000 mm	With viewing panel made from PMMA (acrylic glass)	1 m	LFP2000-N1BMB	1071135			
			2 m	LFP2000-N1CMB	1071138			
	With closed cover	2,000 mm	1 m	LFP2000-N2BMB	1071144			
			2 m	LFP2000-N2CMB	1071146			
G 3/4 A	With viewing panel made from PMMA (acrylic glass)	3,000 mm	2 m	LFP3000-G1CMB	1072031			
3/4" NPT		3,000 mm	2 m	LFP3000-N1CMB	1072032			
G 3/4 A		4,000 mm	1 m	LFP4000-G1BMB	1072030			
3/4" NPT		4,000 mm	1 m	LFP4000-N1BMB	1072033			

## Type code

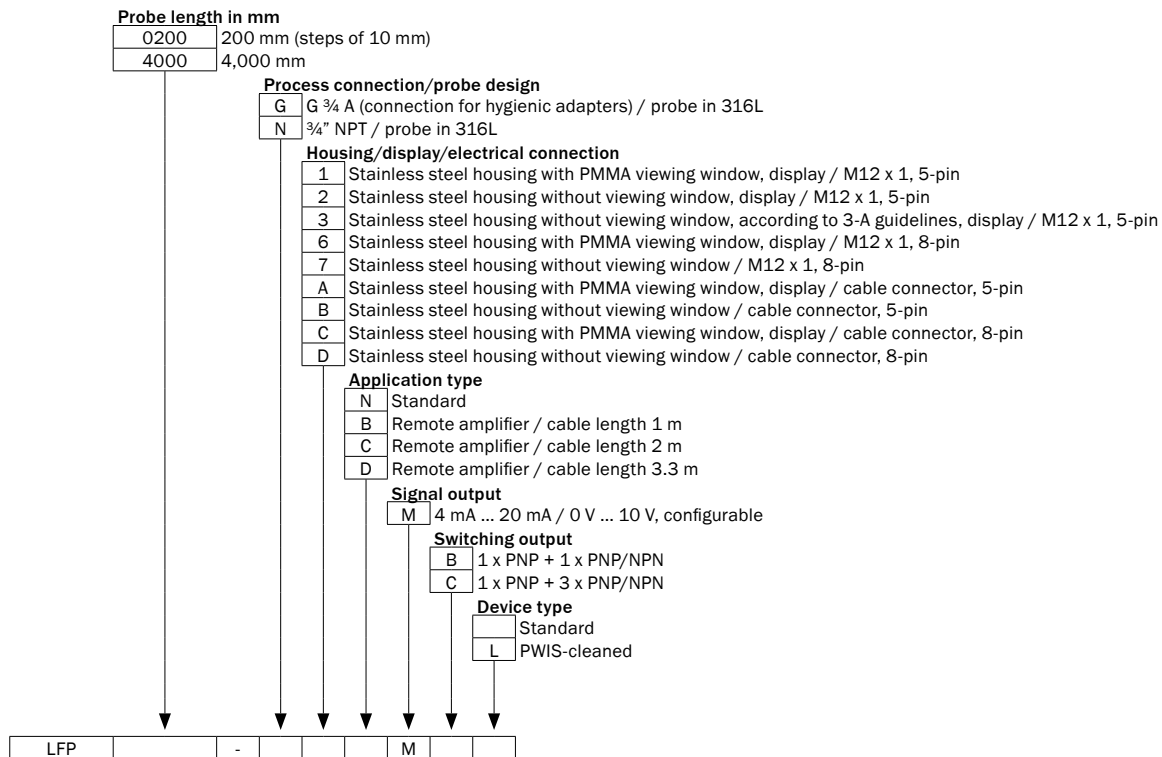

Not all variations of the type code can be combined!

### Max. probe length (mm)

Coaxial cable length (mm)	Foam mode inactive	Foam mode active
1,000	4,000	2,000
2,000	3,000	1,500
3,300	1,000	500

Dimensional drawings (Dimensions in mm (inch))

Standard

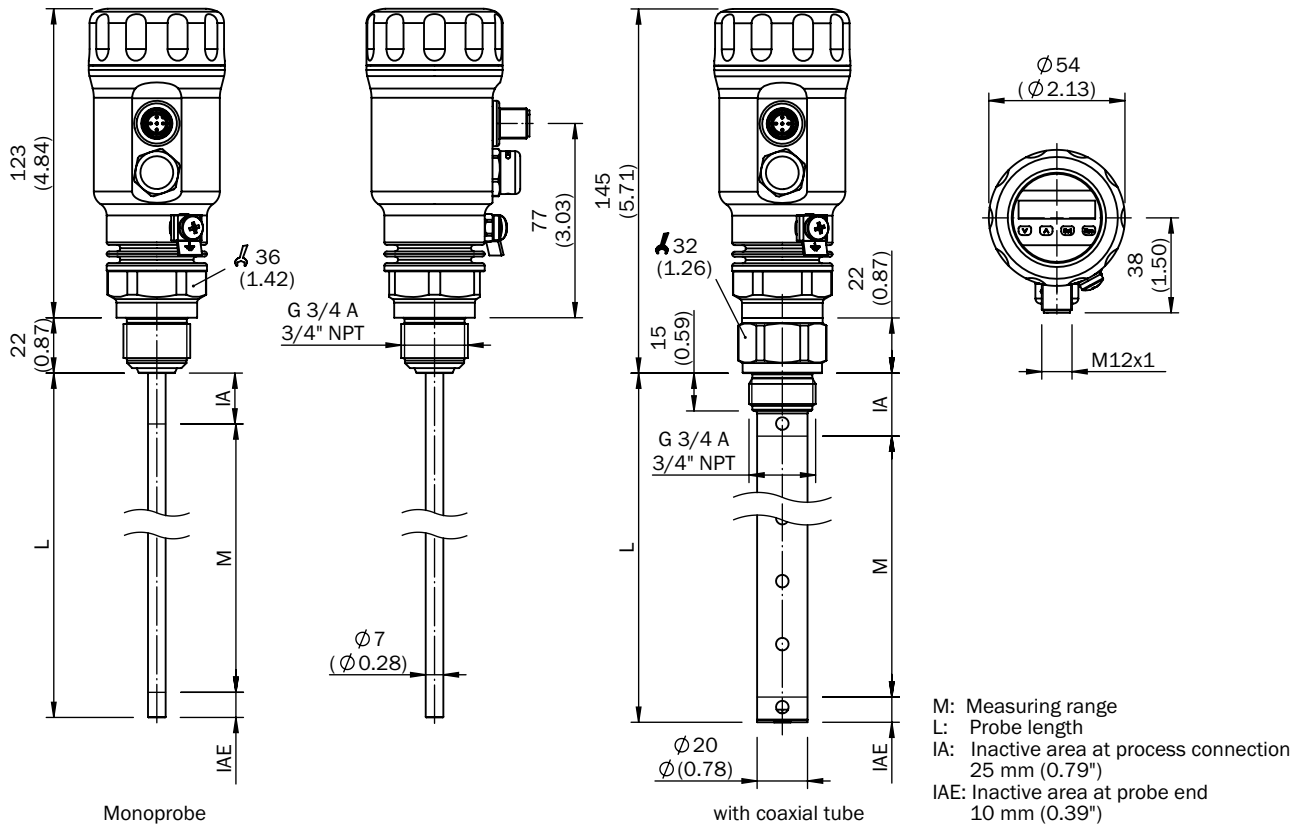

Cable connector

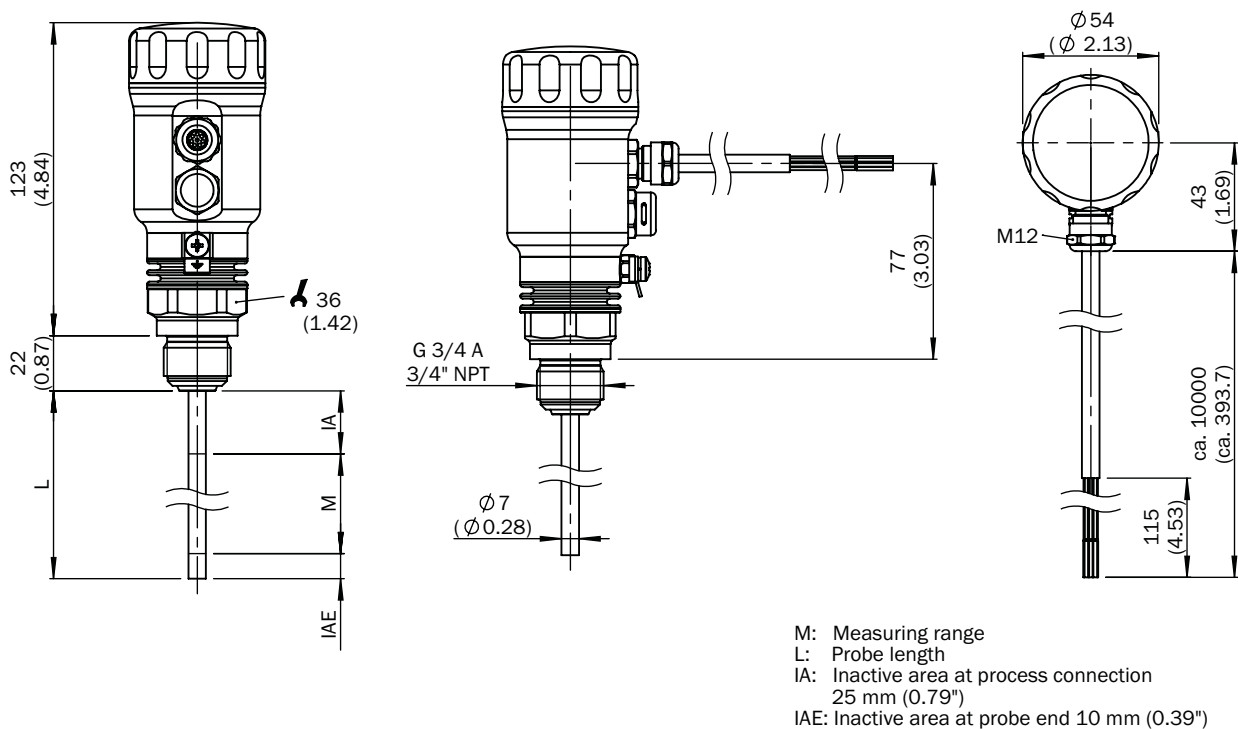



Remote amplifier

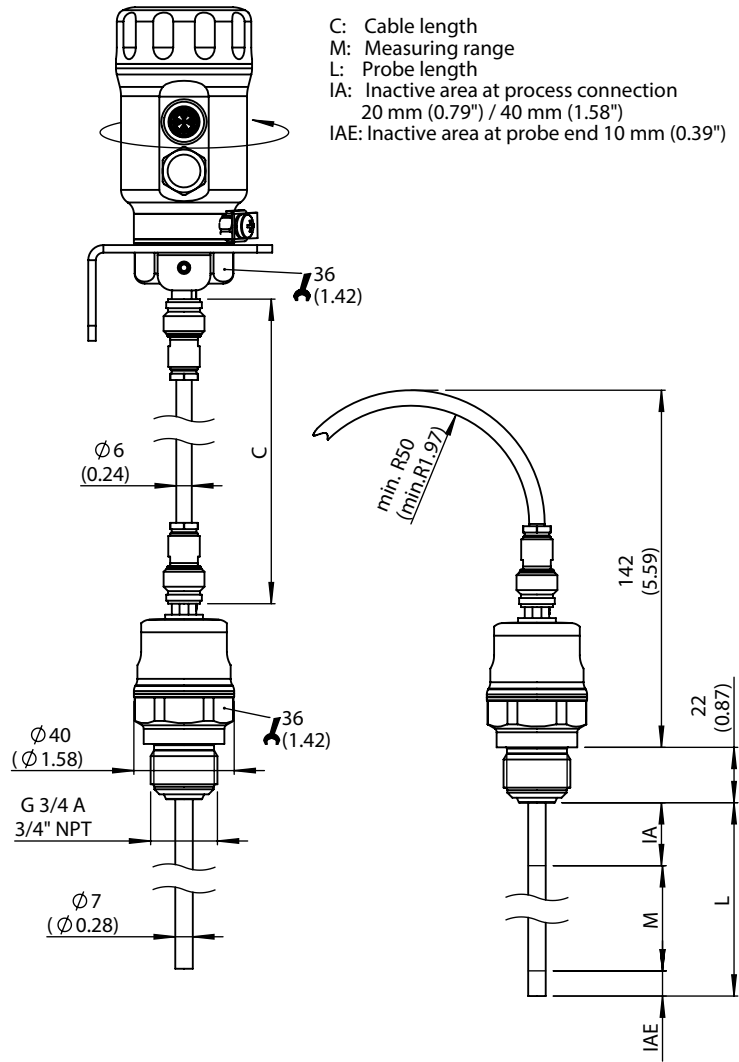
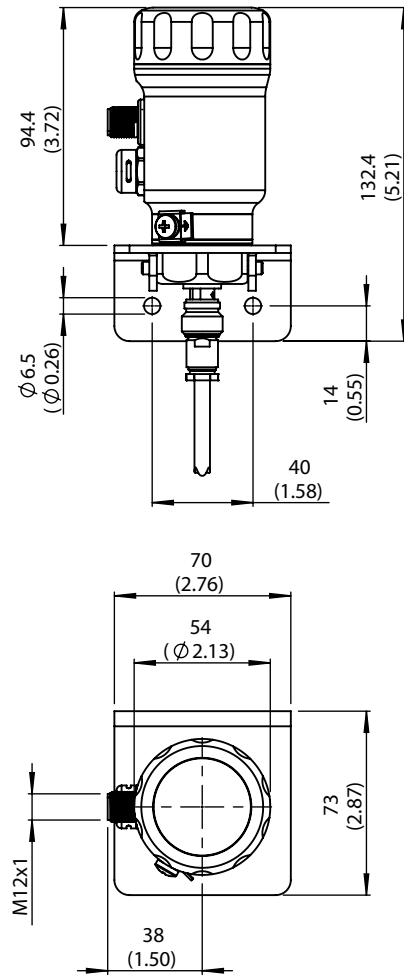

- C: Cable length
- M: Measuring range
- L: Probe length
- IA: Inactive area at process connection  
20 mm (0.79") / 40 mm (1.58")
- IAE: Inactive area at probe end 10 mm (0.39")

All dimensions in mm (inch)

Connection type

M12 round connector, 5-pin

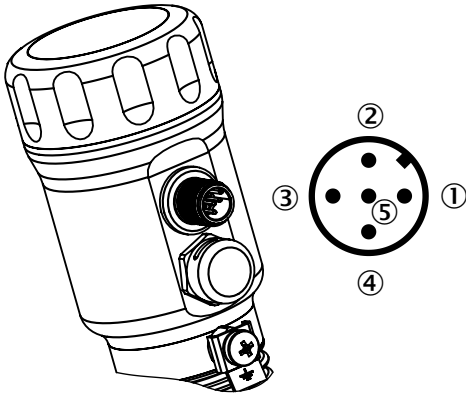

- ① L\*: Supply voltage, brown
- ② Q<sub>A</sub>: Analog current-/voltage output, white
- ③ M: Ground, reference ground for current-/voltage output, blue
- ④ C/Q<sub>1</sub>: Switching output 1, PNP/IO-Link-communication, black
- ⑤ Q<sub>2</sub>: Switching output 2, PNP/NPN, grey

M12 round connector, 8-pin

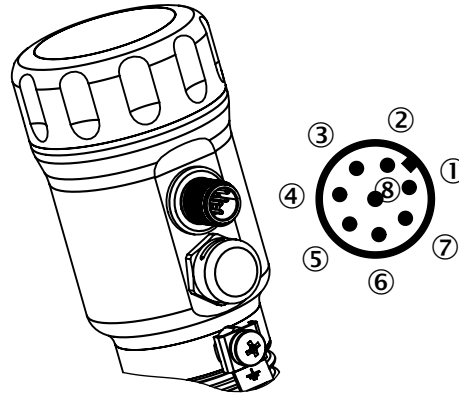

- ① L\*: Supply voltage
- ② Q<sub>2</sub>: Switching output 2, PNP/NPN
- ③ M: Ground, reference ground for current-/voltage output
- ④ C/Q<sub>1</sub>: Switching output 1, PNP/IO-Link-communication
- ⑤ Q<sub>3</sub>: Switching output 3, PNP/NPN
- ⑥ Q<sub>4</sub>: Switching output 4, PNP/NPN
- ⑦ Q<sub>A</sub>: Analog current-/voltage output
- ⑧ No function

Cable connector, 5-pin

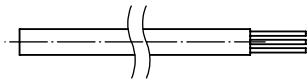

- L\*: Supply voltage, brown
- Q<sub>A</sub>: Analog current-/voltage output, white
- M: Ground, reference ground for current-/voltage output, blue
- C/Q<sub>1</sub>: Switching output 1, PNP/IO-Link-communication, black
- Q<sub>2</sub>: Switching output 2, PNP/NPN, grey

Cable connector, 8-pin

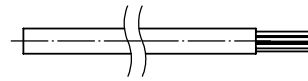

- L\*: Supply voltage, white
- Q<sub>2</sub>: Switching output 2, PNP/NPN, brown
- M: Ground, reference ground for current-/voltage output, green
- C/Q<sub>1</sub>: Switching output 1, PNP/IO-Link-communication, yellow
- Q<sub>3</sub>: Switching output 3, PNP/NPN, gray
- Q<sub>4</sub>: Switching output 4, PNP/NPN, rose
- Q<sub>A</sub>: Analog current-/voltage output, blue
- No function, red

## Accessories

### Mounting systems













#### Mounting brackets and mounting plates

##### Mounting brackets



	Brief description	Type	Part no.
	Mounting bracket, mounting hardware included	BEF-FL-304LFP-HLDR	2077391

##### Flanges

##### Flange plates

	Brief description	Type	Part no.
	Hygienic process connection adapter, collar connector (DIN 11864-1) DN 25 Form A with grooved union nut	BEF-HA-641D25-LFP1	2058795
	Hygienic process connection adapter, collar connector (DIN 11864-2) DN 25 Form A	BEF-HA-642D25-LFP1	2058823
	Hygienic process connection adapter, collar clamp connector (DIN 11864-3) BKS DN 25 Form A	BEF-HA-643D25-LFP1	2058821
	Hygienic process connection adapter, conical connector (DIN 11851) DN 25 with grooved union nut	BEF-HA-851D25-LFP1	2058138
	Hygienic process connection adapter, conical connector (DIN 11851) DN 40 with grooved union nut, material 1.4404 (Ra ≤ 0.8 μm)	BEF-HA-851D40-LFP1	2058139
	Hygienic process connection adapter, conical connector (DIN 11851) DN 50 with grooved union nut	BEF-HA-851D50-LFP1	2058141
	Hygienic process connection adapter, conical connector (DIN 11851) DN 65 with grooved union nut	BEF-HA-851D65-LFP1	2063328
	Hygienic process connection adapter, Tri-Clamp 1" and 1 1/2"	BEF-HA-TCLI10-LFP1	2058808
	Hygienic process connection adapter, Tri-Clamp 1" and 1 1/2" with leakage indication port according to 3-A guidelines	BEF-HA-TCLI10-LFP3	2058851
	Hygienic process connection adapter, Tri-Clamp 2"	BEF-HA-TCLI20-LFP1	2058824
	Hygienic process connection adapter, Tri-Clamp 2 1/2"	BEF-HA-TCLI25-LFP1	2069518
	Hygienic process connection adapter, Tri-Clamp 3"	BEF-HA-TCLI30-LFP1	2064771
	Hygienic process connection adapter, Varivent Connector Type N	BEF-HA-VARTYN-LFP1	2058822

##### Weld-in flange

	Brief description	Type	Part no.
	Welded flange/welded connector, process connection Tri-Clamp 1", Stainless steel 1.4404	BEF-FL-TCLI10-LFV2	5321678
	Welded flange/welded connector, process connection Tri-Clamp 2", Stainless steel 1.4404	BEF-FL-TCLI20-LFV2	5321679
	Welded flange hygienic G 3/4", Stainless steel 1.4404	BEF-HA-SWFL54-LFP1	2061268

BEF-HA-641D25-LFP1

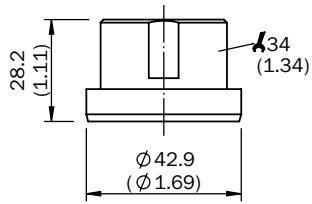

BEF-HA-643D25-LFP1

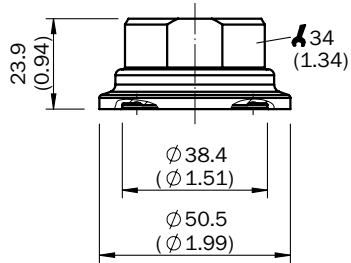

BEF-HA-851D25-LFP1

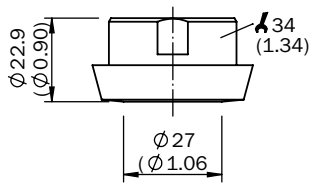

BEF-HA-851D40-LFP1

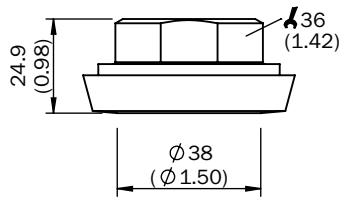

BEF-HA-851D50-LFP1

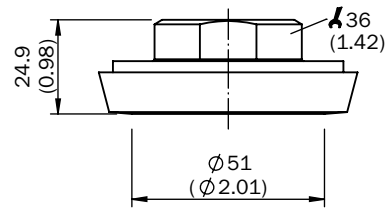

BEF-HA-851D65-LFP1

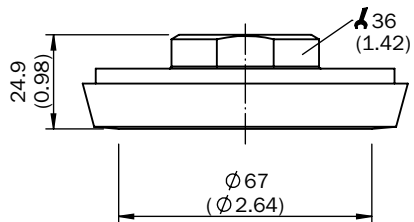

BEF-HA-TCLI10-LFP1

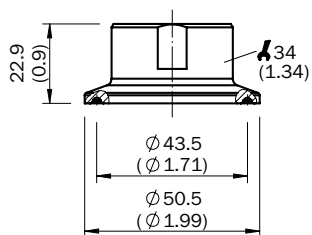

BEF-HA-TCLI10-LFP3

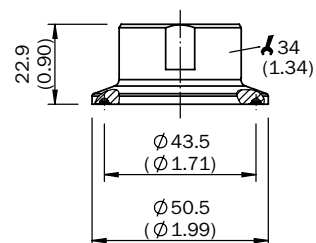

BEF-HA-TCLI20-LFP1

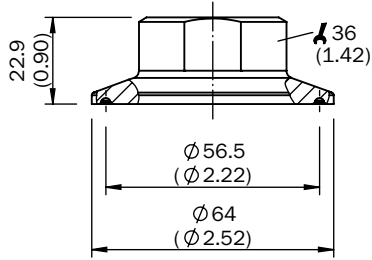

BEF-HA-TCLI25-LFP1

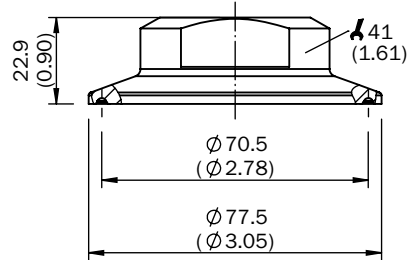

BEF-HA-TCLI30-LFP1

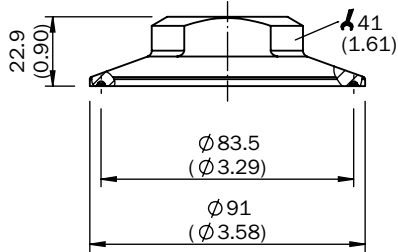

BEF-HA-VARTYN-LFP1

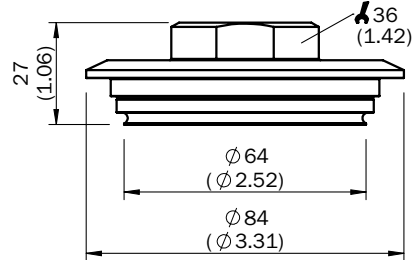

BEF-HA-SWFL54-LFP1

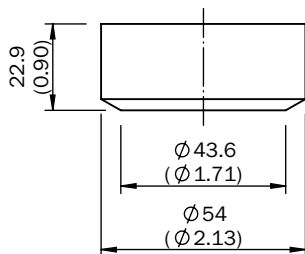

Device protection (mechanical)

Protective housings and protective pipes

	Brief description	Type	Part no.
	Coaxial probe for LFP with process connection G 3/4, process connection of coaxial probe G 3/4, material 1.4571/316TI, for probe length 200 mm	LFPCT-0200G1	2068141
	Coaxial probe for LFP with process connection G 3/4, process connection of coaxial probe 3/4" NPT, material 1.4571/316TI, for probe length 200 mm	LFPCT-0200N1	2068165
	Coaxial probe for LFP with process connection G 3/4, process connection of coaxial probe G 3/4, material 1.4571/316TI, for probe length 300 mm	LFPCT-0300G1	2068142
	Coaxial probe for LFP with process connection G 3/4, process connection of coaxial probe 3/4" NPT, material 1.4571/316TI, for probe length 300 mm	LFPCT-0300N1	2068166
	Coaxial probe for LFP with process connection G 3/4, process connection of coaxial probe G 3/4, material 1.4571/316TI, for probe length 400 mm	LFPCT-0400G1	2068143
	Coaxial probe for LFP with process connection G 3/4, process connection of coaxial probe 3/4" NPT, material 1.4571/316TI, for probe length 400 mm	LFPCT-0400N1	2068167
	Coaxial probe for LFP with process connection G 3/4, process connection of coaxial probe G 3/4, material 1.4571/316TI, for probe length 500 mm	LFPCT-0500G1	2068144
	Coaxial probe for LFP with process connection G 3/4, process connection of coaxial probe 3/4" NPT, material 1.4571/316TI, for probe length 500 mm	LFPCT-0500N1	2068168
	Coaxial probe for LFP with process connection G 3/4, process connection of coaxial probe G 3/4, material 1.4571/316TI, for probe length 600 mm	LFPCT-0600G1	2068145
	Coaxial probe for LFP with process connection G 3/4, process connection of coaxial probe 3/4" NPT, material 1.4571/316TI, for probe length 600 mm	LFPCT-0600N1	2068169
	Coaxial probe for LFP with process connection G 3/4, process connection of coaxial probe G 3/4, material 1.4571/316TI, for probe length 700 mm	LFPCT-0700G1	2068146
	Coaxial probe for LFP with process connection G 3/4, process connection of coaxial probe 3/4" NPT, material 1.4571/316TI, for probe length 700 mm	LFPCT-0700N1	2068170
	Coaxial probe for LFP with process connection G 3/4, process connection of coaxial probe G 3/4, material 1.4571/316TI, for probe length 800 mm	LFPCT-0800G1	2068147
	Coaxial probe for LFP with process connection G 3/4, process connection of coaxial probe 3/4" NPT, material 1.4571/316TI, for probe length 800 mm	LFPCT-0800N1	2068171
	Coaxial probe for LFP with process connection G 3/4, process connection of coaxial probe G 3/4, material 1.4571/316TI, for probe length 900 mm	LFPCT-0900G1	2067507
	Coaxial probe for LFP with process connection G 3/4, process connection of coaxial probe G 3/4, material 1.4571/316TI, for probe length 1,000 mm	LFPCT-1000G1	2065702
	Coaxial probe for LFP with process connection G 3/4, process connection of coaxial probe G 3/4, material 1.4571/316TI, for probe length 1,100 mm	LFPCT-1100G1	2068148
	Coaxial probe for LFP with process connection G 3/4, process connection of coaxial probe G 3/4, material 1.4571/316TI, for probe length 1,200 mm	LFPCT-1200G1	2068149
	Coaxial probe for LFP with process connection G 3/4, process connection of coaxial probe G 3/4, material 1.4571/316TI, for probe length 1,300 mm	LFPCT-1300G1	2068150
	Coaxial probe for LFP with process connection G 3/4, process connection of coaxial probe G 3/4, material 1.4571/316TI, for probe length 1,400 mm	LFPCT-1400G1	2068151
	Coaxial probe for LFP with process connection G 3/4, process connection of coaxial probe G 3/4, material 1.4571/316TI, for probe length 1,500 mm	LFPCT-1500G1	2068152
	Coaxial probe for LFP with process connection G 3/4, process connection of coaxial probe G 3/4, material 1.4571/316TI, for probe length 1,600 mm	LFPCT-1600G1	2068153
	Coaxial probe for LFP with process connection G 3/4, process connection of coaxial probe G 3/4, material 1.4571/316TI, for probe length 1,700 mm	LFPCT-1700G1	2068154
	Coaxial probe for LFP with process connection G 3/4, process connection of coaxial probe G 3/4, material 1.4571/316TI, for probe length 1500 mm	LFPCT-1800G1	2068155
	Coaxial probe for LFP with process connection G 3/4, process connection of coaxial probe G 3/4, material 1.4571/316TI, for probe length 1,900 mm	LFPCT-1900G1	2068156
	Coaxial probe for LFP with process connection G 3/4, process connection of coaxial probe G 3/4, material 1.4571/316TI, for probe length 2,000 mm	LFPCT-2000G1	2065703

  
 Illustration may differ

## Terminal and alignment brackets

## Alignment brackets

	Brief description	Type	Part no.
	1 piece, Centering for bypass- and immersion tube installation with diameter 40 mm ... 100 mm, PTFE	BEF-FL-BYRD40-LFP1	2059612

## Connection systems

## Modules and gateways

## Fieldbus modules

	Brief description	Type	Part no.
	Number of IO-Link ports: 4; Communication mode: COM1/COM2; IO-Link version: IO-Link V1.0; Switching input: PNP; Supply voltage Vs, IO-Link ports: DC 24 V; Current loading: 800 mA; Data transmission rate: Max. 12 MBaud, Autobaud; Address space occupation: 1 bis 126; Connection type: Connector M12; Connection type, IO-Link ports: Connector M12, 5-pin; Supply voltage Vs, module: DC 18 V ... 30 V; Power consumption: Typ. 75 mA / max. 100 mA (at UL with DC 24 V), Typ. 25 mA + sensor current / max. 80	IOLSHPB-P3104R01	6039728

## Plug connectors and cables

## Connecting cables with female connector

	Brief description	Type	Part no.
	Head A: female connector, M12, 5-pin, straight Head B: cable Cable: PVC, unshielded, 2 m This product is generally resistant to chemical cleaning agents (see ECOLAB). Please do not use cleaning agents of any other Kind.	DOL-1205-G02MNI	6052625
	Head A: female connector, M12, 5-pin, straight Head B: cable Cable: PVC, unshielded, 5 m This product is generally resistant to chemical cleaning agents (see ECOLAB). Please do not use cleaning agents of any other Kind.	DOL-1205-G05MNI	6052626
	Head A: female connector, M12, 5-pin, straight Head B: cable Cable: PVC, unshielded, 10 m This product is generally resistant to chemical cleaning agents (see ECOLAB). Please do not use cleaning agents of any other Kind.	DOL-1205-G10MNI	6052627

## Further accessories

## Hardware



Brief description	Type	Part no.
Weather protection cover for LFP Inox, material: 304	APR-WP-LFP001-0001	2069530

## Spare parts

	Brief description	Type	Part no.
 Illustration may differ	Spare coaxial cable for LFP Inox, remote amplifier, length 1 m	CBL-CX-001000-LFPI	2077795
	Spare coaxial cable for LFP Inox, remote amplifier, length 2 m	CBL-CX-002000-LFPI	2077796
	Spare coaxial cable for LFP Inox, remote amplifier, length 3.3 m	CBL-CX-003300-LFPI	2077797
	Cover closed for LFP Inox, material 1.4305	Cover with viewing window	2067269
	Cover for LFP Inox with inspection window, material 1.4305 and PMMA	Cover without viewing window	2067267

## FLEXIBLE UP TO THE PROBE TIP

**Additional information**

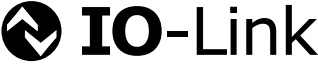
Detailed technical data . . . . .	25
Ordering information . . . . .	26
Type code . . . . .	34
Dimensional drawings . . . . .	35
Connection type . . . . .	38
Accessories . . . . .	38

### Product description

The LFP Cubic is a level sensor for liquids using TDR technology – a process for determining the time of flight of electromagnetic waves. The time difference between the sent pulse and the reflected pulse is used to generate a level signal. The sensor can emit this as a continuous measured value (analog output) and a freely positionable switching point (switching output). The LFP Cubic is compatible for use in virtually

any liquid. Thanks to its modular probe, the sensor can be integrated quickly into any application. It can even be used in deposit-forming and foaming liquids. The sensor’s intuitive setup uses four push-buttons and a display to ensure quick and easy adaptation to the application. Remote amplifier, IO-Link interface, and a design which features a process connection in titanium are additional features for versatile use.

### At a glance

- Level sensor for liquids
- No mechanical moving parts
- Interchangeable and retractable probe from 200 mm to 2,000 mm and cable probe up to 4,000 mm
- Resistant to deposit formation
- Process temperature up to 100 °C; process pressure up to 10 bar
- 3-in-1: combined display, analog output (according to NAMUR NE 43), and binary output
- High enclosure rating of IP67, rotatable housing and remote amplifier

### Your benefits

- Rugged design increases service life
- High flexibility due to cutable and exchangeable monoprobe or rope probe
- Cost savings due to multiple output signals: one system for both level detection and continuous level monitoring
- Time and cost savings due to low maintenance and quick commissioning without calibration
- Titanium process connection brings high chemical resistance
- Compact and rotatable housing or remote amplifier ensures flexible installation
- No crosstalk when several sensors are mounted next to each other
- Advanced technology enables adjustment-free measurement

→ [www.sick.com/LFP\\_Cubic](http://www.sick.com/LFP_Cubic)

For more information, simply enter the link or scan the QR code and get direct access to technical data, CAD design models, operating instructions, software, application examples, and much more.





## Detailed technical data

## Features

Medium	Fluids
Measurement	Switch, Continuous
Design	Standard Remote amplifier, length of cable 1 m Remote amplifier, length of cable 2 m Remote amplifier, length of cable 3.3 m (depending on type)
Probe type	Without probe Rod probe Rope probe (depending on type)
Probe length	200 mm ... 2,000 mm (rod probe) 1,000 mm, 2,000 mm, 3,000 mm, 4,000 mm (rope probe)
Process pressure	-1 bar ... +10 bar
Process temperature	-20 °C ... +100 °C
GOST approval	✓
RoHS certificate	✓
IO-Link	✓
CULus certificate	✓
PWIS-cleaned	- / ✓ (depending on type)

## Performance

Accuracy of sensor element	± 5 mm <sup>1)</sup>
Repeatability	≤ 2 mm
Resolution	< 2 mm
Response time	< 400 ms
Dielectricity constant	≥ 5 for mono rod probe / rope probe ≥ 1.8 with coaxial probe
Conductivity	No limitation
Maximum level change	≤ 500 mm/s
Deactivated area at end of probe	10 mm <sup>2)</sup>
MTTF	194.3 years (EN ISO 13849-1)

<sup>1)</sup> For details see accuracy diagram in the operating instructions LFP Cubic.

<sup>2)</sup> With water under reference conditions.

## Mechanics

Wetted parts	1.4404, PTFE
Process connection	G ¾ A ¾" NPT G ¾ A, Titanium ¾" NPT, Titanium (depending on type)
Housing material	Plastic PBT
Max.probe load	≤ 6 Nm
Material coaxial cable	PVC
Length coaxial cable	1 m ... 3.3 m (depending on type)

## Electronics

Supply voltage	12 V DC ... 30 V DC <sup>1)</sup>
Power consumption	≤ 100 mA at 24 V DC without output load

<sup>1)</sup> All connections are polarity protected. All outputs are overload and short-circuit protected.

Initialization time	≤ 5 s
Protection class	III
Electrical connection	Round connector M12 x 1, 5-pin Round connector M12 x 1, 8-pin (depending on type)
Output signal	4 mA ... 20 mA, 0 V ... 10 V automatic switching depending on the load, 1 PNP transistor output (Q1) and 1 PNP/NPN transistor output (Q2) switchable, or 1 PNP transistor output (Q1) and 3 PNP/NPN transistor outputs (Q2 ... Q4) switchable (depending on type) <sup>1)</sup>
Output load	4 mA ... 20 mA < 500 Ohm at U <sub>v</sub> > 15 V 4 mA ... 20 mA < 350 Ohm at U <sub>v</sub> > 12 V 0 V ... 10 V > 750 Ohm at U <sub>v</sub> 14 ≥ V
Hysteresis	Min. 2 mm, free adjustable
Signal voltage HIGH	V <sub>s</sub> - 2 V
Signal voltage LOW	≤ 2 V
Output current	< 100 mA
Inductive load	< 1 H
Capacitive load	100 nF
Enclosure rating	IP 67: EN 60529
Temperature drift	< 0.1 mm/K
Lower signal level	3.8 mA ... 4 mA
Upper signal level	20 mA ... 20.5 mA

<sup>1)</sup> All connections are polarity protected. All outputs are overload and short-circuit protected.

### Ambient data

Ambient operating temperature	-20 °C ... +60 °C
Ambient storage temperature	-40 °C ... +80 °C
Ambient temperature coaxial cable	-20 °C ... +60 °C
Outdoor use	Unsuitable

### Ordering information

#### Without probe

- **Enclosure rating:** IP 67: EN 60529
- **Process temperature:** -20 °C ... +100 °C
- **Process pressure:** -1 bar ... 10 bar
- **Housing material:** Plastic PBT

Process connection	Output signal	Electrical connection	Type	Part no.
G ¾ A	1 x PNP + 1 x PNP/NPN + 4 mA ... 20 mA / 0 V ... 10 V	Round connector M12 x 1, 5-pin	LFP0025-A4NMB	1060171
G ¾ A, Titanium		Round connector M12 x 1, 5-pin	LFP0025-A4NMBS01	1062791
G ¾ A	1 x PNP + 3 x PNP/NPN + 4 mA ... 20 mA / 0 V ... 10 V	Round connector M12 x 1, 8-pin	LFP0025-A5NMC	1064676
G ¾ A, Titanium		Round connector M12 x 1, 8-pin	LFP0025-A5NMCS05	1070517
¾" NPT	1 x PNP + 1 x PNP/NPN + 4 mA ... 20 mA / 0 V ... 10 V	Round connector M12 x 1, 5-pin	LFP0025-B4NMB	1060172
¾" NPT, Titanium		Round connector M12 x 1, 5-pin	LFP0025-B4NMBS10	1075980
¾" NPT	1 x PNP + 3 x PNP/NPN + 4 mA ... 20 mA / 0 V ... 10 V	Round connector M12 x 1, 8-pin	LFP0025-B5NMC	1068941

## Rod probe with standard amplifier

- **Enclosure rating:** IP 67: EN 60529
- **Process temperature:** -20 °C ... +100 °C
- **Process pressure:** -1 bar ... 10 bar
- **Housing material:** Plastic PBT

Process connection	Output signal	Electrical connection	Probe length	Type	Part no.
G ¾ A	1 x PNP + 1 x PNP/NPN + 4 mA ... 20 mA / 0 V ... 10 V	Round connector M12 x 1, 5-pin	200 mm	LFP0200-A4NMB	1057073
	1 x PNP + 3 x PNP/NPN + 4 mA ... 20 mA / 0 V ... 10 V	Round connector M12 x 1, 8-pin	200 mm	LFP0200-A5NMC	1062245
¾" NPT	1 x PNP + 1 x PNP/NPN + 4 mA ... 20 mA / 0 V ... 10 V	Round connector M12 x 1, 5-pin	200 mm	LFP0200-B4NMB	1057092
	1 x PNP + 3 x PNP/NPN + 4 mA ... 20 mA / 0 V ... 10 V	Round connector M12 x 1, 8-pin	200 mm	LFP0200-B5NMC	1062264
G ¾ A	1 x PNP + 1 x PNP/NPN + 4 mA ... 20 mA / 0 V ... 10 V	Round connector M12 x 1, 5-pin	300 mm	LFP0300-A4NMB	1057074
	1 x PNP + 3 x PNP/NPN + 4 mA ... 20 mA / 0 V ... 10 V	Round connector M12 x 1, 8-pin	300 mm	LFP0300-A5NMC	1062246
¾" NPT	1 x PNP + 1 x PNP/NPN + 4 mA ... 20 mA / 0 V ... 10 V	Round connector M12 x 1, 5-pin	300 mm	LFP0300-B4NMB	1057093
	1 x PNP + 3 x PNP/NPN + 4 mA ... 20 mA / 0 V ... 10 V	Round connector M12 x 1, 8-pin	300 mm	LFP0300-B5NMC	1062265
G ¾ A	1 x PNP + 1 x PNP/NPN + 4 mA ... 20 mA / 0 V ... 10 V	Round connector M12 x 1, 5-pin	400 mm	LFP0400-A4NMB	1057075
	1 x PNP + 3 x PNP/NPN + 4 mA ... 20 mA / 0 V ... 10 V	Round connector M12 x 1, 8-pin	400 mm	LFP0400-A5NMC	1062247
¾" NPT	1 x PNP + 1 x PNP/NPN + 4 mA ... 20 mA / 0 V ... 10 V	Round connector M12 x 1, 5-pin	400 mm	LFP0400-B4NMB	1057094
	1 x PNP + 3 x PNP/NPN + 4 mA ... 20 mA / 0 V ... 10 V	Round connector M12 x 1, 8-pin	400 mm	LFP0400-B5NMC	1062266
G ¾ A	1 x PNP + 1 x PNP/NPN + 4 mA ... 20 mA / 0 V ... 10 V	Round connector M12 x 1, 5-pin	500 mm	LFP0500-A4NMB	1057076
	1 x PNP + 3 x PNP/NPN + 4 mA ... 20 mA / 0 V ... 10 V	Round connector M12 x 1, 8-pin	500 mm	LFP0500-A5NMC	1062248
¾" NPT	1 x PNP + 1 x PNP/NPN + 4 mA ... 20 mA / 0 V ... 10 V	Round connector M12 x 1, 5-pin	500 mm	LFP0500-B4NMB	1057095
	1 x PNP + 3 x PNP/NPN + 4 mA ... 20 mA / 0 V ... 10 V	Round connector M12 x 1, 8-pin	500 mm	LFP0500-B5NMC	1062267
G ¾ A	1 x PNP + 1 x PNP/NPN + 4 mA ... 20 mA / 0 V ... 10 V	Round connector M12 x 1, 5-pin	600 mm	LFP0600-A4NMB	1057077
	1 x PNP + 3 x PNP/NPN + 4 mA ... 20 mA / 0 V ... 10 V	Round connector M12 x 1, 8-pin	600 mm	LFP0600-A5NMC	1062249

Process connection	Output signal	Electrical connection	Probe length	Type	Part no.
¾" NPT	1 x PNP + 1 x PNP/NPN + 4 mA ... 20 mA / 0 V ... 10 V	Round connector M12 x 1, 5-pin	600 mm	LFP0600-B4NMB	1057096
	1 x PNP + 3 x PNP/NPN + 4 mA ... 20 mA / 0 V ... 10 V	Round connector M12 x 1, 8-pin	600 mm	LFP0600-B5NMC	1062268
G ¾ A	1 x PNP + 1 x PNP/NPN + 4 mA ... 20 mA / 0 V ... 10 V	Round connector M12 x 1, 5-pin	700 mm	LFP0700-A4NMB	1057078
	1 x PNP + 3 x PNP/NPN + 4 mA ... 20 mA / 0 V ... 10 V	Round connector M12 x 1, 8-pin	700 mm	LFP0700-A5NMC	1062250
¾" NPT	1 x PNP + 1 x PNP/NPN + 4 mA ... 20 mA / 0 V ... 10 V	Round connector M12 x 1, 5-pin	700 mm	LFP0700-B4NMB	1057097
	1 x PNP + 3 x PNP/NPN + 4 mA ... 20 mA / 0 V ... 10 V	Round connector M12 x 1, 8-pin	700 mm	LFP0700-B5NMC	1062269
G ¾ A	1 x PNP + 1 x PNP/NPN + 4 mA ... 20 mA / 0 V ... 10 V	Round connector M12 x 1, 5-pin	800 mm	LFP0800-A4NMB	1057079
	1 x PNP + 3 x PNP/NPN + 4 mA ... 20 mA / 0 V ... 10 V	Round connector M12 x 1, 8-pin	800 mm	LFP0800-A5NMC	1062251
¾" NPT	1 x PNP + 1 x PNP/NPN + 4 mA ... 20 mA / 0 V ... 10 V	Round connector M12 x 1, 5-pin	800 mm	LFP0800-B4NMB	1057098
	1 x PNP + 3 x PNP/NPN + 4 mA ... 20 mA / 0 V ... 10 V	Round connector M12 x 1, 8-pin	800 mm	LFP0800-B5NMC	1062270
G ¾ A	1 x PNP + 1 x PNP/NPN + 4 mA ... 20 mA / 0 V ... 10 V	Round connector M12 x 1, 5-pin	900 mm	LFP0900-A4NMB	1057080
	1 x PNP + 3 x PNP/NPN + 4 mA ... 20 mA / 0 V ... 10 V	Round connector M12 x 1, 8-pin	900 mm	LFP0900-A5NMC	1062252
¾" NPT	1 x PNP + 1 x PNP/NPN + 4 mA ... 20 mA / 0 V ... 10 V	Round connector M12 x 1, 5-pin	900 mm	LFP0900-B4NMB	1057099
	1 x PNP + 3 x PNP/NPN + 4 mA ... 20 mA / 0 V ... 10 V	Round connector M12 x 1, 8-pin	900 mm	LFP0900-B5NMC	1062271
G ¾ A	1 x PNP + 1 x PNP/NPN + 4 mA ... 20 mA / 0 V ... 10 V	Round connector M12 x 1, 5-pin	1,000 mm	LFP1000-A4NMB	1057081
				LFP1000-A4NMBL	1073549
	1 x PNP + 3 x PNP/NPN + 4 mA ... 20 mA / 0 V ... 10 V	Round connector M12 x 1, 8-pin	1,000 mm	LFP1000-A5NMC	1062253
¾" NPT	1 x PNP + 1 x PNP/NPN + 4 mA ... 20 mA / 0 V ... 10 V	Round connector M12 x 1, 5-pin	1,000 mm	LFP1000-B4NMB	1057100
	1 x PNP + 3 x PNP/NPN + 4 mA ... 20 mA / 0 V ... 10 V	Round connector M12 x 1, 8-pin	1,000 mm	LFP1000-B5NMC	1062272
G ¾ A	1 x PNP + 1 x PNP/NPN + 4 mA ... 20 mA / 0 V ... 10 V	Round connector M12 x 1, 5-pin	1,100 mm	LFP1100-A4NMB	1057082
	1 x PNP + 3 x PNP/NPN + 4 mA ... 20 mA / 0 V ... 10 V	Round connector M12 x 1, 8-pin	1,100 mm	LFP1100-A5NMC	1062254

Process connection	Output signal	Electrical connection	Probe length	Type	Part no.
¾" NPT	1 x PNP + 1 x PNP/NPN + 4 mA ... 20 mA / 0 V ... 10 V	Round connector M12 x 1, 5-pin	1,100 mm	LFP1100-B4NMB	1057101
	1 x PNP + 3 x PNP/NPN + 4 mA ... 20 mA / 0 V ... 10 V	Round connector M12 x 1, 8-pin	1,100 mm	LFP1100-B5NMC	1062273
G ¾ A	1 x PNP + 1 x PNP/NPN + 4 mA ... 20 mA / 0 V ... 10 V	Round connector M12 x 1, 5-pin	1,200 mm	LFP1200-A4NMB	1057083
	1 x PNP + 3 x PNP/NPN + 4 mA ... 20 mA / 0 V ... 10 V	Round connector M12 x 1, 8-pin	1,200 mm	LFP1200-A5NMC	1062255
¾" NPT	1 x PNP + 1 x PNP/NPN + 4 mA ... 20 mA / 0 V ... 10 V	Round connector M12 x 1, 5-pin	1,200 mm	LFP1200-B4NMB	1057102
	1 x PNP + 3 x PNP/NPN + 4 mA ... 20 mA / 0 V ... 10 V	Round connector M12 x 1, 8-pin	1,200 mm	LFP1200-B5NMC	1062274
G ¾ A	1 x PNP + 1 x PNP/NPN + 4 mA ... 20 mA / 0 V ... 10 V	Round connector M12 x 1, 5-pin	1,300 mm	LFP1300-A4NMB	1057084
	1 x PNP + 3 x PNP/NPN + 4 mA ... 20 mA / 0 V ... 10 V	Round connector M12 x 1, 8-pin	1,300 mm	LFP1300-A5NMC	1062256
¾" NPT	1 x PNP + 1 x PNP/NPN + 4 mA ... 20 mA / 0 V ... 10 V	Round connector M12 x 1, 5-pin	1,300 mm	LFP1300-B4NMB	1057103
	1 x PNP + 3 x PNP/NPN + 4 mA ... 20 mA / 0 V ... 10 V	Round connector M12 x 1, 8-pin	1,300 mm	LFP1300-B5NMC	1062275
G ¾ A	1 x PNP + 1 x PNP/NPN + 4 mA ... 20 mA / 0 V ... 10 V	Round connector M12 x 1, 5-pin	1,400 mm	LFP1400-A4NMB	1057085
	1 x PNP + 3 x PNP/NPN + 4 mA ... 20 mA / 0 V ... 10 V	Round connector M12 x 1, 8-pin	1,400 mm	LFP1400-A5NMC	1062257
¾" NPT	1 x PNP + 1 x PNP/NPN + 4 mA ... 20 mA / 0 V ... 10 V	Round connector M12 x 1, 5-pin	1,400 mm	LFP1400-B4NMB	1057104
	1 x PNP + 3 x PNP/NPN + 4 mA ... 20 mA / 0 V ... 10 V	Round connector M12 x 1, 8-pin	1,400 mm	LFP1400-B5NMC	1062276
G ¾ A	1 x PNP + 1 x PNP/NPN + 4 mA ... 20 mA / 0 V ... 10 V	Round connector M12 x 1, 5-pin	1,500 mm	LFP1500-A4NMB	1057086
	1 x PNP + 3 x PNP/NPN + 4 mA ... 20 mA / 0 V ... 10 V	Round connector M12 x 1, 8-pin	1,500 mm	LFP1500-A5NMC	1062258
¾" NPT	1 x PNP + 1 x PNP/NPN + 4 mA ... 20 mA / 0 V ... 10 V	Round connector M12 x 1, 5-pin	1,500 mm	LFP1500-B4NMB	1057105
	1 x PNP + 3 x PNP/NPN + 4 mA ... 20 mA / 0 V ... 10 V	Round connector M12 x 1, 8-pin	1,500 mm	LFP1500-B5NMC	1062277
G ¾ A	1 x PNP + 1 x PNP/NPN + 4 mA ... 20 mA / 0 V ... 10 V	Round connector M12 x 1, 5-pin	1,600 mm	LFP1600-A4NMB	1057087
	1 x PNP + 3 x PNP/NPN + 4 mA ... 20 mA / 0 V ... 10 V	Round connector M12 x 1, 8-pin	1,600 mm	LFP1600-A5NMC	1062259

Process connection	Output signal	Electrical connection	Probe length	Type	Part no.
¾" NPT	1 x PNP + 1 x PNP/NPN + 4 mA ... 20 mA / 0 V ... 10 V	Round connector M12 x 1, 5-pin	1,600 mm	LFP1600-B4NMB	1057106
	1 x PNP + 3 x PNP/NPN + 4 mA ... 20 mA / 0 V ... 10 V	Round connector M12 x 1, 8-pin	1,600 mm	LFP1600-B5NMC	1062278
G ¾ A	1 x PNP + 1 x PNP/NPN + 4 mA ... 20 mA / 0 V ... 10 V	Round connector M12 x 1, 5-pin	1,700 mm	LFP1700-A4NMB	1057088
	1 x PNP + 3 x PNP/NPN + 4 mA ... 20 mA / 0 V ... 10 V	Round connector M12 x 1, 8-pin	1,700 mm	LFP1700-A5NMC	1062260
¾" NPT	1 x PNP + 1 x PNP/NPN + 4 mA ... 20 mA / 0 V ... 10 V	Round connector M12 x 1, 5-pin	1,700 mm	LFP1700-B4NMB	1057107
	1 x PNP + 3 x PNP/NPN + 4 mA ... 20 mA / 0 V ... 10 V	Round connector M12 x 1, 8-pin	1,700 mm	LFP1700-B5NMC	1062279
G ¾ A	1 x PNP + 1 x PNP/NPN + 4 mA ... 20 mA / 0 V ... 10 V	Round connector M12 x 1, 5-pin	1,800 mm	LFP1800-A4NMB	1057089
	1 x PNP + 3 x PNP/NPN + 4 mA ... 20 mA / 0 V ... 10 V	Round connector M12 x 1, 8-pin	1,800 mm	LFP1800-A5NMC	1062261
¾" NPT	1 x PNP + 1 x PNP/NPN + 4 mA ... 20 mA / 0 V ... 10 V	Round connector M12 x 1, 5-pin	1,800 mm	LFP1800-B4NMB	1057108
	1 x PNP + 3 x PNP/NPN + 4 mA ... 20 mA / 0 V ... 10 V	Round connector M12 x 1, 8-pin	1,800 mm	LFP1800-B5NMC	1062280
G ¾ A	1 x PNP + 1 x PNP/NPN + 4 mA ... 20 mA / 0 V ... 10 V	Round connector M12 x 1, 5-pin	1,900 mm	LFP1900-A4NMB	1057090
	1 x PNP + 3 x PNP/NPN + 4 mA ... 20 mA / 0 V ... 10 V	Round connector M12 x 1, 8-pin	1,900 mm	LFP1900-A5NMC	1062262
¾" NPT	1 x PNP + 1 x PNP/NPN + 4 mA ... 20 mA / 0 V ... 10 V	Round connector M12 x 1, 5-pin	1,900 mm	LFP1900-B4NMB	1057109
	1 x PNP + 3 x PNP/NPN + 4 mA ... 20 mA / 0 V ... 10 V	Round connector M12 x 1, 8-pin	1,900 mm	LFP1900-B5NMC	1062281
G ¾ A	1 x PNP + 1 x PNP/NPN + 4 mA ... 20 mA / 0 V ... 10 V	Round connector M12 x 1, 5-pin	2,000 mm	LFP2000-A4NMB	1057091
	1 x PNP + 3 x PNP/NPN + 4 mA ... 20 mA / 0 V ... 10 V	Round connector M12 x 1, 8-pin	2,000 mm	LFP2000-A5NMC	1062263
¾" NPT	1 x PNP + 1 x PNP/NPN + 4 mA ... 20 mA / 0 V ... 10 V	Round connector M12 x 1, 5-pin	2,000 mm	LFP2000-B4NMB	1057110
	1 x PNP + 3 x PNP/NPN + 4 mA ... 20 mA / 0 V ... 10 V	Round connector M12 x 1, 8-pin	2,000 mm	LFP2000-B5NMC	1062282

Rod probe with remote amplifier

- **Enclosure rating:** IP 67: EN 60529
- **Process temperature:** -20 °C ... +100 °C
- **Process pressure:** -1 bar ... 10 bar
- **Housing material:** Plastic PBT

Process connection	Output signal	Electrical connection	Probe length	Cable length	Type	Part no.
G ¾ A	1 x PNP + 1 x PNP/ NPN + 4 mA ... 20 mA / 0 V ... 10 V	Round connector M12 x 1, 5-pin	300 mm	3.3 m	LFP0300-A4DMB	1071084
	1 x PNP + 3 x PNP/ NPN + 4 mA ... 20 mA / 0 V ... 10 V	Round connector M12 x 1, 8-pin	300 mm	3.3 m	LFP0300-A5DMC	1071094
¾" NPT	1 x PNP + 1 x PNP/ NPN + 4 mA ... 20 mA / 0 V ... 10 V	Round connector M12 x 1, 5-pin	300 mm	3.3 m	LFP0300-B4DMB	1071104
	1 x PNP + 3 x PNP/ NPN + 4 mA ... 20 mA / 0 V ... 10 V	Round connector M12 x 1, 8-pin	300 mm	3.3 m	LFP0300-B5DMC	1071114
G ¾ A	1 x PNP + 1 x PNP/ NPN + 4 mA ... 20 mA / 0 V ... 10 V	Round connector M12 x 1, 5-pin	500 mm	1 m	LFP0500-A4BMB	1071078
				2 m	LFP0500-A4CMB	1071081
				3.3 m	LFP0500-A4DMB	1071085
	1 x PNP + 3 x PNP/ NPN + 4 mA ... 20 mA / 0 V ... 10 V	Round connector M12 x 1, 8-pin	500 mm	1 m	LFP0500-A5BMC	1071088
				2 m	LFP0500-A5CMC	1071091
				3.3 m	LFP0500-A5DMC	1071095
¾" NPT	1 x PNP + 1 x PNP/ NPN + 4 mA ... 20 mA / 0 V ... 10 V	Round connector M12 x 1, 5-pin	500 mm	1 m	LFP0500-B4BMB	1071098
				2 m	LFP0500-B4CMB	1071101
				3.3 m	LFP0500-B4DMB	1071105
	1 x PNP + 3 x PNP/ NPN + 4 mA ... 20 mA / 0 V ... 10 V	Round connector M12 x 1, 8-pin	500 mm	1 m	LFP0500-B5BMC	1071108
				2 m	LFP0500-B5CMC	1071111
				3.3 m	LFP0500-B5DMC	1071115
G ¾ A	1 x PNP + 1 x PNP/ NPN + 4 mA ... 20 mA / 0 V ... 10 V	Round connector M12 x 1, 5-pin	700 mm	3.3 m	LFP0700-A4DMB	1071086
	1 x PNP + 3 x PNP/ NPN + 4 mA ... 20 mA / 0 V ... 10 V	Round connector M12 x 1, 8-pin	700 mm	3.3 m	LFP0700-A5DMC	1071096
¾" NPT	1 x PNP + 1 x PNP/ NPN + 4 mA ... 20 mA / 0 V ... 10 V	Round connector M12 x 1, 5-pin	700 mm	3.3 m	LFP0700-B4DMB	1071106
	1 x PNP + 3 x PNP/ NPN + 4 mA ... 20 mA / 0 V ... 10 V	Round connector M12 x 1, 8-pin	700 mm	3.3 m	LFP0700-B5DMC	1071116
G ¾ A	1 x PNP + 1 x PNP/ NPN + 4 mA ... 20 mA / 0 V ... 10 V	Round connector M12 x 1, 5-pin	1,000 mm	1 m	LFP1000-A4BMB	1071079
				2 m	LFP1000-A4CMB	1071082
				3.3 m	LFP1000-A4DMB	1071087
	1 x PNP + 3 x PNP/ NPN + 4 mA ... 20 mA / 0 V ... 10 V	Round connector M12 x 1, 8-pin	1,000 mm	1 m	LFP1000-A5BMC	1071089
				2 m	LFP1000-A5CMC	1071092
				3.3 m	LFP1000-A5DMC	1071097

Process connection	Output signal	Electrical connection	Probe length	Cable length	Type	Part no.
¾" NPT	1 x PNP + 1 x PNP/ NPN + 4 mA ... 20 mA / 0 V ... 10 V	Round connector M12 x 1, 5-pin	1,000 mm	1 m	LFP1000-B4BMB	1071099
				2 m	LFP1000-B4CMB	1071102
	1 x PNP + 3 x PNP/ NPN + 4 mA ... 20 mA / 0 V ... 10 V	Round connector M12 x 1, 8-pin	1,000 mm	1 m	LFP1000-B5BMC	1071109
				2 m	LFP1000-B5CMC	1071112
				3.3 m	LFP1000-B5DMC	1071117
G ¾ A	1 x PNP + 1 x PNP/ NPN + 4 mA ... 20 mA / 0 V ... 10 V	Round connector M12 x 1, 5-pin	2,000 mm	1 m	LFP2000-A4BMB	1071080
				2 m	LFP2000-A4CMB	1071083
	1 x PNP + 3 x PNP/ NPN + 4 mA ... 20 mA / 0 V ... 10 V	Round connector M12 x 1, 8-pin	2,000 mm	1 m	LFP2000-A5BMC	1071090
				2 m	LFP2000-A5CMC	1071093
¾" NPT	1 x PNP + 1 x PNP/ NPN + 4 mA ... 20 mA / 0 V ... 10 V	Round connector M12 x 1, 5-pin	2,000 mm	1 m	LFP2000-B4BMB	1071100
				2 m	LFP2000-B4CMB	1071103
	1 x PNP + 3 x PNP/ NPN + 4 mA ... 20 mA / 0 V ... 10 V	Round connector M12 x 1, 8-pin	2,000 mm	1 m	LFP2000-B5BMC	1071110
				2 m	LFP2000-B5CMC	1071113

Rope probe with standard amplifier

- **Enclosure rating:** IP 67: EN 60529
- **Process temperature:** -20 °C ... +100 °C
- **Process pressure:** -1 bar ... 10 bar
- **Housing material:** Plastic PBT

Process connection	Output signal	Electrical connection	Probe length	Type	Part no.
G ¾ A	1 x PNP + 1 x PNP/NPN + 4 mA ... 20 mA / 0 V ... 10 V	Round connector M12 x 1, 5-pin	1,000 mm	LFP1000-E4NMB	1066785
¾" NPT		Round connector M12 x 1, 5-pin	1,000 mm	LFP1000-F4NMB	1066792
G ¾ A		Round connector M12 x 1, 5-pin	2,000 mm	LFP2000-E4NMB	1066786
¾" NPT		Round connector M12 x 1, 5-pin	2,000 mm	LFP2000-F4NMB	1066791
G ¾ A		Round connector M12 x 1, 5-pin	3,000 mm	LFP3000-E4NMB	1066787
¾" NPT		Round connector M12 x 1, 5-pin	3,000 mm	LFP3000-F4NMB	1066790
G ¾ A		Round connector M12 x 1, 5-pin	4,000 mm	LFP4000-E4NMB	1066788
		Round connector M12 x 1, 8-pin	4,000 mm	LFP4000-E5NMC	1070139
¾" NPT		Round connector M12 x 1, 5-pin	4,000 mm	LFP4000-F4NMB	1066789
		Round connector M12 x 1, 8-pin	4,000 mm	LFP4000-F5NMC	1070140



## Rope probe with remote amplifier

- **Enclosure rating:** IP 67: EN 60529
- **Process temperature:** -20 °C ... +100 °C
- **Process pressure:** -1 bar ... 10 bar
- **Housing material:** Plastic PBT

Process connection	Output signal	Electrical connection	Probe length	Cable length	Type	Part no.
G ¾ A	1 x PNP + 1 x PNP/ NPN + 4 mA ... 20 mA / 0 V ... 10 V	Round connector M12 x 1, 5-pin	1,000 mm	3.3 m	LFP1000-E4DMB	1072019
	1 x PNP + 3 x PNP/ NPN + 4 mA ... 20 mA / 0 V ... 10 V	Round connector M12 x 1, 8-pin	1,000 mm	3.3 m	LFP1000-E5DMC	1072020
¾" NPT	1 x PNP + 1 x PNP/ NPN + 4 mA ... 20 mA / 0 V ... 10 V	Round connector M12 x 1, 5-pin	1,000 mm	3.3 m	LFP1000-F4DMB	1072090
	1 x PNP + 3 x PNP/ NPN + 4 mA ... 20 mA / 0 V ... 10 V	Round connector M12 x 1, 8-pin	1,000 mm	3.3 m	LFP1000-F5DMC	1072029
G ¾ A	1 x PNP + 1 x PNP/ NPN + 4 mA ... 20 mA / 0 V ... 10 V	Round connector M12 x 1, 5-pin	3,000 mm	2 m	LFP3000-E4CMB	1072018
	1 x PNP + 3 x PNP/ NPN + 4 mA ... 20 mA / 0 V ... 10 V	Round connector M12 x 1, 8-pin	3,000 mm	2 m	LFP3000-E5CMC	1072021
¾" NPT	1 x PNP + 1 x PNP/ NPN + 4 mA ... 20 mA / 0 V ... 10 V	Round connector M12 x 1, 5-pin	3,000 mm	2 m	LFP3000-F4CMB	1072026
	1 x PNP + 3 x PNP/ NPN + 4 mA ... 20 mA / 0 V ... 10 V	Round connector M12 x 1, 8-pin	3,000 mm	2 m	LFP3000-F5CMC	1072025
G ¾ A	1 x PNP + 1 x PNP/ NPN + 4 mA ... 20 mA / 0 V ... 10 V	Round connector M12 x 1, 5-pin	4,000 mm	1 m	LFP4000-E4BMB	1072017
	1 x PNP + 3 x PNP/ NPN + 4 mA ... 20 mA / 0 V ... 10 V	Round connector M12 x 1, 8-pin	4,000 mm	1 m	LFP4000-E5BMC	1072022
¾" NPT	1 x PNP + 1 x PNP/ NPN + 4 mA ... 20 mA / 0 V ... 10 V	Round connector M12 x 1, 5-pin	4,000 mm	1 m	LFP4000-F4BMB	1072023
	1 x PNP + 3 x PNP/ NPN + 4 mA ... 20 mA / 0 V ... 10 V	Round connector M12 x 1, 8-pin	4,000 mm	1 m	LFP4000-F5BMC	1072024

## Type code

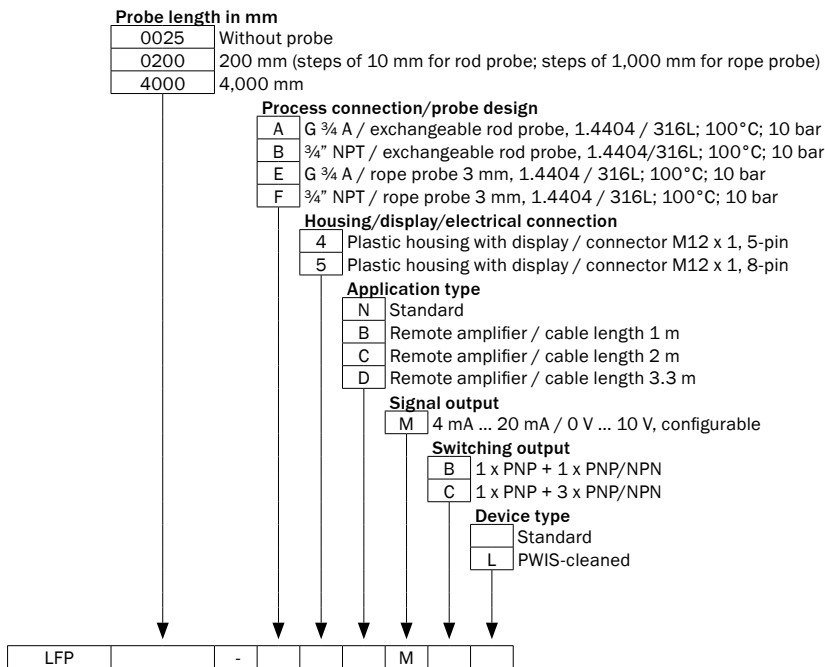

Not all variations of the type code can be combined!

### Max. probe length (mm)

Coaxial cable length (mm)	Foam mode inactive	Foam mode active
1,000	4,000	2,000
2,000	3,000	1,500
3,300	1,000	500

Dimensional drawings (Dimensions in mm (inch))

Rod probe

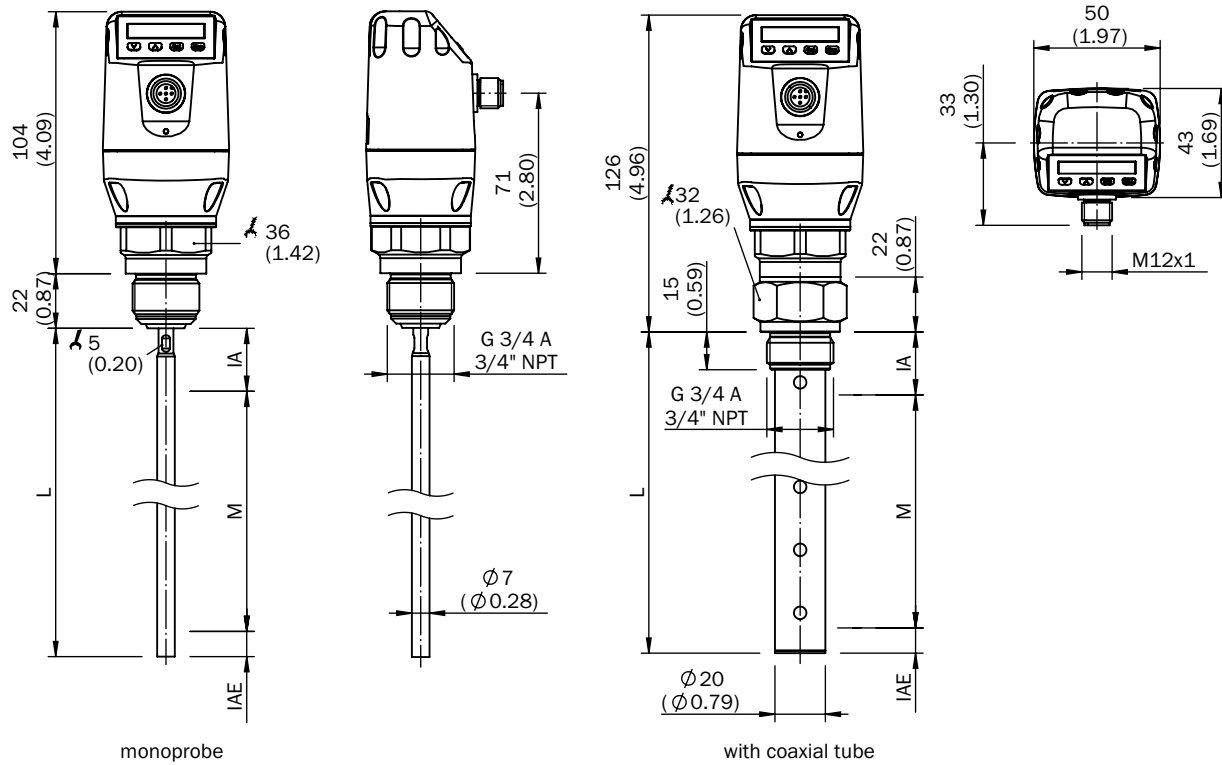

- ① M: measuring range
- ② L: Probe length
- ③ IA: Inactive area at process connection 25 mm (0.98")
- ④ IAE: Inactive area at probe end 10 mm (0.39")

Rope probe

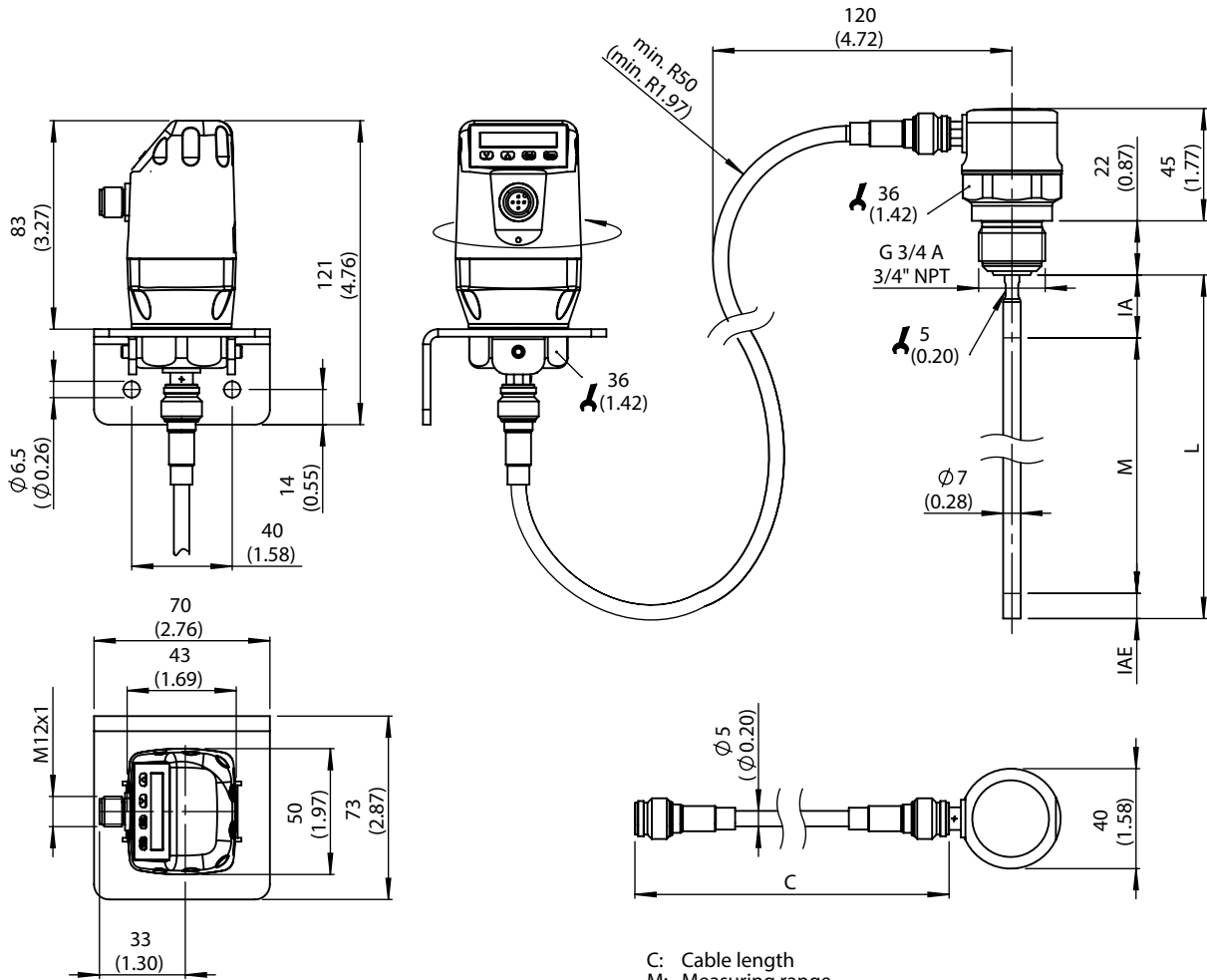

All dimensions in mm (inch)

- C: Cable length
- M: Measuring range
- L: Probe length
- IA: Inactive area at process connection  
20 mm (0.79") / 40 mm (1.58")
- IAE: Inactive area at probe end 10 mm (0.39")

Remote amplifier

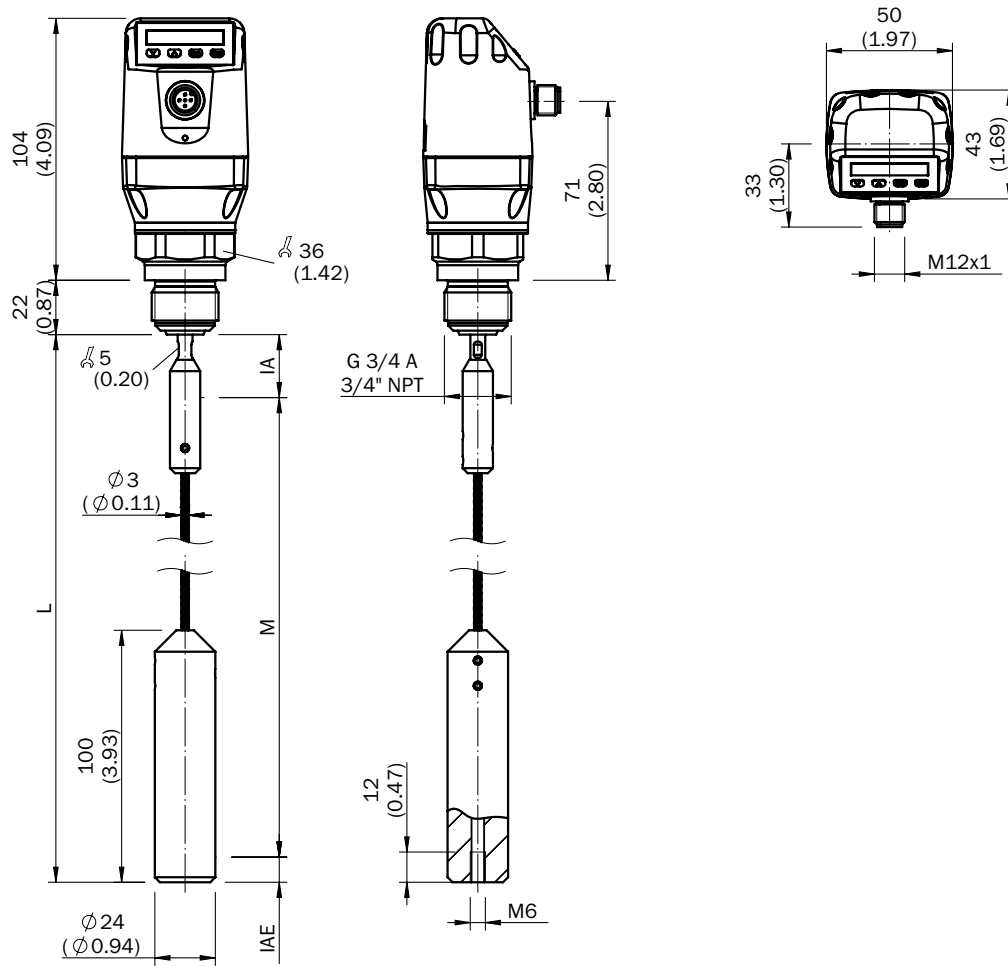

- ① M: measuring range
- ② L: Probe length
- ③ IA: Inactive area at process connection 25 mm (0.98")
- ④ IAE: Inactive area at probe end 10 mm (0.39")

## Connection type

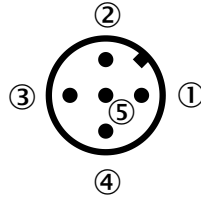
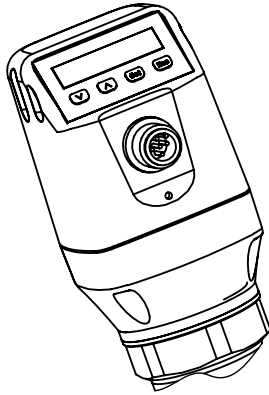

- ① L: Supply voltage, brown
- ② Q<sub>A</sub>: Analog current-/voltage output, white
- ③ M: Ground, reference ground for current-/voltage output, blue
- ④ C/Q<sub>1</sub>: Switching output 1, PNP/IO-Link-communication, black
- ⑤ Q<sub>2</sub>: Switching output 2, PNP/NPN, grey

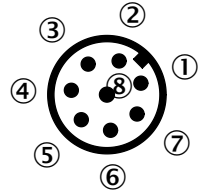
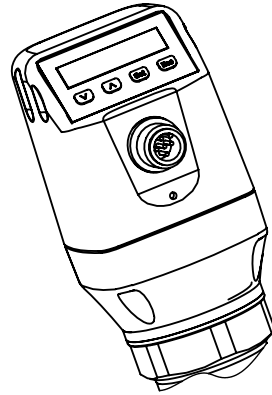

- ① L: Supply voltage
- ② Q<sub>2</sub>: Switching output 2, PNP/NPN
- ③ M: Ground, reference ground for current-/voltage output
- ④ C/Q<sub>1</sub>: Switching output 1, PNP/IO-Link-communication
- ⑤ Q<sub>3</sub>: Switching output 3, PNP/NPN
- ⑥ Q<sub>4</sub>: Switching output 4, PNP/NPN
- ⑦ Q<sub>A</sub>: Analog current-/voltage output
- ⑧ No function

## Accessories

### Mounting systems

Device protection (mechanical)

Protective housings and protective pipes

	Brief description	Type	Part no.
<p>Illustration may differ</p>	Coaxial probe for LFP with process connection G 3/4, process connection of coaxial probe G 3/4, material 1.4571/316TI, for probe length 200 mm	LFPCT-0200G1	2068141
	Coaxial probe for LFP with process connection G 3/4, process connection of coaxial probe 3/4" NPT, material 1.4571/316TI, for probe length 200 mm	LFPCT-0200N1	2068165
	Coaxial probe for LFP with process connection G 3/4, process connection of coaxial probe G 3/4, material 1.4571/316TI, for probe length 300 mm	LFPCT-0300G1	2068142
	Coaxial probe for LFP with process connection G 3/4, process connection of coaxial probe 3/4" NPT, material 1.4571/316TI, for probe length 300 mm	LFPCT-0300N1	2068166
	Coaxial probe for LFP with process connection G 3/4, process connection of coaxial probe G 3/4, material 1.4571/316TI, for probe length 400 mm	LFPCT-0400G1	2068143
	Coaxial probe for LFP with process connection G 3/4, process connection of coaxial probe 3/4" NPT, material 1.4571/316TI, for probe length 400 mm	LFPCT-0400N1	2068167
	Coaxial probe for LFP with process connection G 3/4, process connection of coaxial probe G 3/4, material 1.4571/316TI, for probe length 500 mm	LFPCT-0500G1	2068144
	Coaxial probe for LFP with process connection G 3/4, process connection of coaxial probe 3/4" NPT, material 1.4571/316TI, for probe length 500 mm	LFPCT-0500N1	2068168
	Coaxial probe for LFP with process connection G 3/4, process connection of coaxial probe G 3/4, material 1.4571/316TI, for probe length 600 mm	LFPCT-0600G1	2068145
	Coaxial probe for LFP with process connection G 3/4, process connection of coaxial probe 3/4" NPT, material 1.4571/316TI, for probe length 600 mm	LFPCT-0600N1	2068169
	Coaxial probe for LFP with process connection G 3/4, process connection of coaxial probe G 3/4, material 1.4571/316TI, for probe length 700 mm	LFPCT-0700G1	2068146
	Coaxial probe for LFP with process connection G 3/4, process connection of coaxial probe 3/4" NPT, material 1.4571/316TI, for probe length 700 mm	LFPCT-0700N1	2068170
	Coaxial probe for LFP with process connection G 3/4, process connection of coaxial probe G 3/4, material 1.4571/316TI, for probe length 800 mm	LFPCT-0800G1	2068147

	Brief description	Type	Part no.
	Coaxial probe for LFP with process connection G 3/4, process connection of coaxial probe 3/4" NPT, material 1.4571/316TI, for probe length 800 mm	LFPCT-0800N1	2068171
	Coaxial probe for LFP with process connection G 3/4, process connection of coaxial probe G 3/4, material 1.4571/316TI, for probe length 900 mm	LFPCT-0900G1	2067507
	Coaxial probe for LFP with process connection G 3/4, process connection of coaxial probe 3/4" NPT, material 1.4571/316TI, for probe length 900 mm	LFPCT-0900N1	2068172
	Coaxial probe for LFP with process connection G 3/4, process connection of coaxial probe G 3/4, material 1.4571/316TI, for probe length 1000 mm	LFPCT-1000G1	2065702
	Coaxial probe for LFP with process connection G 3/4, process connection of coaxial probe 3/4" NPT, material 1.4571/316TI, for probe length 1000 mm	LFPCT-1000N1	2068173
	Coaxial probe for LFP with process connection G 3/4, process connection of coaxial probe G 3/4, material 1.4571/316TI, for probe length 1100 mm	LFPCT-1100G1	2068148
	Coaxial probe for LFP with process connection G 3/4, process connection of coaxial probe 3/4" NPT, material 1.4571/316TI, for probe length 1100 mm	LFPCT-1100N1	2068174
	Coaxial probe for LFP with process connection G 3/4, process connection of coaxial probe G 3/4, material 1.4571/316TI, for probe length 1200 mm	LFPCT-1200G1	2068149
	Coaxial probe for LFP with process connection G 3/4, process connection of coaxial probe 3/4" NPT, material 1.4571/316TI, for probe length 1200 mm	LFPCT-1200N1	2068175
	Coaxial probe for LFP with process connection G 3/4, process connection of coaxial probe G 3/4, material 1.4571/316TI, for probe length 1300 mm	LFPCT-1300G1	2068150
	Coaxial probe for LFP with process connection G 3/4, process connection of coaxial probe 3/4" NPT, material 1.4571/316TI, for probe length 1300 mm	LFPCT-1300N1	2068176
	Coaxial probe for LFP with process connection G 3/4, process connection of coaxial probe G 3/4, material 1.4571/316TI, for probe length 1400 mm	LFPCT-1400G1	2068151
	Coaxial probe for LFP with process connection G 3/4, process connection of coaxial probe 3/4" NPT, material 1.4571/316TI, for probe length 1400 mm	LFPCT-1400N1	2068177
 <p>Illustration may differ</p>	Coaxial probe for LFP with process connection G 3/4, process connection of coaxial probe G 3/4, material 1.4571/316TI, for probe length 1500 mm	LFPCT-1500G1	2068152
	Coaxial probe for LFP with process connection G 3/4, process connection of coaxial probe 3/4" NPT, material 1.4571/316TI, for probe length 1500 mm	LFPCT-1500N1	2068178
	Coaxial probe for LFP with process connection G 3/4, process connection of coaxial probe G 3/4, material 1.4571/316TI, for probe length 1600 mm	LFPCT-1600G1	2068153
	Coaxial probe for LFP with process connection G 3/4, process connection of coaxial probe 3/4" NPT, material 1.4571/316TI, for probe length 1600 mm	LFPCT-1600N1	2068179
	Coaxial probe for LFP with process connection G 3/4, process connection of coaxial probe G 3/4, material 1.4571/316TI, for probe length 1700 mm	LFPCT-1700G1	2068154
	Coaxial probe for LFP with process connection G 3/4, process connection of coaxial probe 3/4" NPT, material 1.4571/316TI, for probe length 1700 mm	LFPCT-1700N1	2068180
	Coaxial probe for LFP with process connection G 3/4, process connection of coaxial probe G 3/4, material 1.4571/316TI, for probe length 1800 mm	LFPCT-1800G1	2068155
	Coaxial probe for LFP with process connection G 3/4, process connection of coaxial probe 3/4" NPT, material 1.4571/316TI, for probe length 1800 mm	LFPCT-1800N1	2068181
	Coaxial probe for LFP with process connection G 3/4, process connection of coaxial probe G 3/4, material 1.4571/316TI, for probe length 1900 mm	LFPCT-1900G1	2068156
	Coaxial probe for LFP with process connection G 3/4, process connection of coaxial probe 3/4" NPT, material 1.4571/316TI, for probe length 1900 mm	LFPCT-1900N1	2068182
	Coaxial probe for LFP with process connection G 3/4, process connection of coaxial probe G 3/4, material 1.4571/316TI, for probe length 2000 mm	LFPCT-2000G1	2065703
	Coaxial probe for LFP with process connection G 3/4, process connection of coaxial probe 3/4" NPT, material 1.4571/316TI, for probe length 2000 mm	LFPCT-2000N1	2068183

Flanges

Flange plates

	Brief description	Type	Part no.
	Process connection adapter G 3/4 to G1	BEF-HA-G1BSP1-LFP1	2067603

Weld-in flange

	Brief description	Type	Part no.
	Weld-in flange G 3/4"	BEF-FL-GEWG34-LFP1	2082150

Terminal and alignment brackets

Alignment brackets

	Brief description	Type	Part no.
	1 piece, Centering for bypass- and immersion tube installation with diameter 40 mm ... 100 mm, PTFE	BEF-FL-BYRD40-LFP1	2059612

Connection systems

Modules and gateways

Fieldbus modules

















	Brief description	Type	Part no.
	Number of IO-Link ports: 4; Communication mode: COM1/COM2; IO-Link version: IO-Link V1.0; Switching input: PNP; Supply voltage Vs, IO-Link ports: DC 24 V; Current loading: 800 mA; Data transmission rate: Max. 12 MBaud, Autobaud; Address space occupation: 1 bis 126; Connection type: Connector M12; Connection type, IO-Link ports: Connector M12, 5-pin; Supply voltage Vs, module: DC 18 V ... 30 V; Power consumption: Typ. 75 mA / max. 100 mA (at UL with DC 24 V), Typ. 25 mA + sensor current / max. 80	IOLSHPB-P3104R01	6039728

Plug connectors and cables

Connecting cables with female connector

	Brief description	Type	Part no.
 Illustration may differ	Head A: female connector, M12, 5-pin, straight Head B: cable Cable: PVC, unshielded, 2 m	DOL-1205-G02M	6008899
	Head A: female connector, M12, 5-pin, straight Head B: cable Cable: drag chain use, PUR, halogen-free, unshielded, 2 m	DOL-1205-G02MC	6025906
 Illustration may differ	Head A: female connector, M12, 5-pin, straight Head B: cable Cable: PVC, unshielded, 5 m	DOL-1205-G05M	6009868
	Head A: female connector, M12, 5-pin, straight Head B: cable Cable: drag chain use, PUR, halogen-free, unshielded, 5 m	DOL-1205-G05MC	6025907
 Illustration may differ	Head A: female connector, M12, 5-pin, straight Head B: cable Cable: PVC, unshielded, 10 m	DOL-1205-G10M	6010544





	Brief description	Type	Part no.
	Head A: female connector, M12, 5-pin, straight Head B: cable Cable: drag chain use, PUR, halogen-free, unshielded, 10 m	DOL-1205-G10MC	6025908
 Illustration may differ	Head A: female connector, M12, 5-pin, angled Head B: cable Cable: PVC, unshielded, 2 m	DOL-1205-W02M	6008900
	Head A: female connector, M12, 5-pin, angled Head B: cable Cable: drag chain use, PUR, halogen-free, unshielded, 2 m	DOL-1205-W02MC	6025909
 Illustration may differ	Head A: female connector, M12, 5-pin, angled Head B: cable Cable: PVC, unshielded, 5 m	DOL-1205-W05M	6009869
	Head A: female connector, M12, 5-pin, angled Head B: cable Cable: drag chain use, PUR, halogen-free, unshielded, 5 m	DOL-1205-W05MC	6025910
 Illustration may differ	Head A: female connector, M12, 5-pin, angled Head B: cable Cable: PVC, unshielded, 10 m	DOL-1205-W10M	6010542
	Head A: female connector, M12, 5-pin, angled Head B: cable Cable: drag chain use, PUR, halogen-free, unshielded, 10 m	DOL-1205-W10MC	6025911
	Head A: female connector, M12, 8-pin, straight Head B: cable Cable: PVC, shielded, 2 m	DOL-1208-G02MA	6020633
	Head A: female connector, M12, 8-pin, straight Head B: cable Cable: drag chain use, PUR, halogen-free, unshielded, 2 m	DOL-1208-G02MC	6035620
	Head A: female connector, M12, 8-pin, straight Head B: cable Cable: PVC, shielded, 5 m	DOL-1208-G05MA	6020993
	Head A: female connector, M12, 8-pin, straight Head B: cable Cable: drag chain use, PUR, halogen-free, unshielded, 5 m	DOL-1208-G05MC	6035621
	Head A: female connector, M12, 8-pin, straight Head B: cable Cable: PVC, shielded, 10 m	DOL-1208-G10MA	6022152
	Head A: female connector, M12, 8-pin, straight Head B: cable Cable: drag chain use, PUR, halogen-free, unshielded, 10 m	DOL-1208-G10MC	6035622
	Head A: female connector, M12, 8-pin, angled Head B: cable Cable: PVC, shielded, 2 m	DOL-1208-W02MA	6020992
	Head A: female connector, M12, 8-pin, angled Head B: cable Cable: PUR, unshielded, 2 m	DOL-1208-W02MC	6035623
	Head A: female connector, M12, 8-pin, angled Head B: cable Cable: PVC, shielded, 5 m	DOL-1208-W05MA	6021033

	Brief description	Type	Part no.
	Head A: female connector, M12, 8-pin, angled Head B: cable Cable: PUR, unshielded, 5 m	DOL-1208-W05MC	6035624
	Head A: female connector, M12, 8-pin, angled Head B: cable Cable: PUR, unshielded, 10 m	DOL-1208-W10MC	6035625

Further accessories

Spare parts

	Brief description	Type	Part no.	
	Spare probe for LFP Cubic, probe length 1,000 mm, material 1.4404/316L, diameter 7 mm	BEF-ER-SN1000-LFPC	2065700	
	Spare probe for LFP Cubic, probe length 2,000 mm, material 1.4404/316L, diameter 7 mm	BEF-ER-SN2000-LFPC	2065701	
	Spare cable probe for LFP Cubic, length 2 m	BEF-ER-SS2000-LFPC	2078194	
	Spare cable probe for LFP Cubic, length 4 m	BEF-ER-SS4000-LFPC	2078195	
	Spare cable probe for LFP Cubic, length 6 m	BEF-ER-SS6000-LFPC	2082147	
	Spare titan probe for LFP Cubic, length 1 m	BEF-ER-TS1000-LFPC	2081042	
	Spare titan probe for LFP Cubic, length 2 m	BEF-ER-TS2000-LFPC	2081043	
		Spare coaxial cable for LFP Cubic, separate amplifier, length 1 m	CBL-CX-001000-LFPC	2077792
		Spare coaxial cable for LFP Cubic separate amplifier, length 2 m	CBL-CX-002000-LFPC	2077793
Spare coaxial cable for LFP Cubic separate amplifier, length 3.3 m		CBL-CX-003300-LFPC	2077794	

## REGISTER AT WWW.SICK.COM TODAY AND ENJOY ALL THE BENEFITS





- ✔ Select products, accessories, documentation and software quickly and easily.
- ✔ Create, save and share personalized wish lists.
- ✔ View the net price and date of delivery for every product.
- ✔ Requests for quotation, ordering and delivery tracking made easy.
- ✔ Overview of all quotations and orders.
- ✔ Direct ordering: submit even very complex orders in moments.
- ✔ View the status of quotations and orders at any time. Receive e-mail notifications of status changes.
- ✔ Easily repeat previous orders.
- ✔ Conveniently export quotations and orders to work with your systems.



## SERVICES FOR MACHINES AND SYSTEMS: SICK LifeTime Services

Our comprehensive and versatile LifeTime Services are the perfect addition to the comprehensive range of products from SICK. The services range from product-independent consulting to traditional product services.



-  **Consulting and design**  
Safe and professional
-  **Product and system support**  
Reliable, fast and on-site
-  **Verification and optimization**  
Safe and regularly inspected
-  **Upgrade and retrofits**  
Easy, safe and economical
-  **Training and education**  
Practical, focused and professional

## SICK AT A GLANCE

SICK is a leading manufacturer of intelligent sensors and sensor solutions for industrial applications. With more than 7,400 employees and over 50 subsidiaries and equity investments as well as numerous representative offices worldwide, we are always close to our customers. A unique range of products and services creates the perfect basis for controlling processes securely and efficiently, protecting individuals from accidents and preventing damage to the environment.

We have extensive experience in various industries and understand their processes and requirements. With intelligent sensors, we can deliver exactly what our customers need. In application centers in Europe, Asia and North America, system solutions are tested and optimized in accordance with customer specifications. All this makes us a reliable supplier and development partner.

Comprehensive services round out our offering: SICK LifeTime Services provide support throughout the machine life cycle and ensure safety and productivity.

For us, that is “Sensor Intelligence.”

### Worldwide presence:

Australia, Austria, Belgium, Brazil, Canada, Chile, China, Czech Republic, Denmark, Finland, France, Germany, Great Britain, Hungary, India, Israel, Italy, Japan, Malaysia, Mexico, Netherlands, New Zealand, Norway, Poland, Romania, Russia, Singapore, Slovakia, Slovenia, South Africa, South Korea, Spain, Sweden, Switzerland, Taiwan, Thailand, Turkey, United Arab Emirates, USA, Vietnam.



**THORNE &  
DERRICK  
INTERNATIONAL**

Thorne & Derrick  
+44 (0) 191 490 1547  
[www.heatingandprocess.com](http://www.heatingandprocess.com)